

Development of Wireless Access Support for EV to Smart Meter Communication in Vehicle-to-Grid (V2G)

Santoshkumar*[‡], Udaykumar R.Y**

*Research Scholar, Department of Electrical and Electronics Engineering, NITK, Surathkal, India-575025.

**Professor, Department of Electrical and Electronics Engineering, NITK, Surathkal, India-575025.

(santoshkumar777@yahoo.com,udaykumarry@yahoo.com)

[‡]Corresponding Author; Santoshkumar,Electrical and Electronics Engineering Department, NITK, Surathkal, India-575025,
Tel: +91 9844027103,santoshkumar777@yahoo.com

Received: 11.01.2015 Accepted:17.05.2015

Abstract-Vehicle -to-Grid (V2G) supports ancillary services like peak shaving, valley filling, load levelling and the battery of the electric vehicle (EV) provide reactive power support to the grid. V2G also helps in maintaining the grid stability for short duration of time. The communication between EV and the Smart Meter is very crucial for smooth functioning of V2G. The WiFi single input single output/multiple input multiple output(SISO/MIMO) protocol is proposed for EV to Smart Meter communication in indoor wireless environment. The channel models B and C are used as they are developed for residential apartment and office buildings due to the fact that EVs are usually parked in these locations. The MIMO environment is considered for simulating these channel models. The physical layer of WiFi (SISO) protocol is modeled in MATLAB/SIMULINK and its performance is investigated.

Keywords-Channel model, EV, Smart Meter, V2G.

1. Introduction

EVs will gradually replace the other vehicles due to growing oil demand and increased carbon emission[1,2]. EVs are usually parked for 90-95% of the time in residential buildings, office complex, parking lots etc. This parking time can be used to connect the EVs to grid through home or other interface. The group of EVs can be integrated to the grid to sell or buy power from the grid known as V2G[3]. The single EV can consume power but cannot pump power back to the grid. The group of EVs makes a sizeable difference and delivers power to the grid. The EVs also support the ancillary services like load leveling, voltage regulation, frequency regulation and balancing. The EV needs bidirectional charger to sell or buy power from the grid. Further the bidirectional charger has the direct current (dc) link capacitor which is inherently able to provide the reactive

power support to the power grid [4,5]. The charging/discharging capabilities of a battery promote the concept of Vehicle-to-Home (V2H), Vehicle-to-Vehicle (V2V) and V2G [6]. EV not only serves as a transportation tool but also acts as controllable load or Distributed Resource (DR).

EV can be connected to the home grid or other interface through the On-Board or Off-Board bidirectional charger [7]. The integrators have to strictly comply with IEEE 1547 standards such as to provide quality power to the customers. The control scheme and state of charge (SOC) of the EV battery decide whether to draw or transfer power. The communication between EV and the Smart Meter plays a key role in the efficient operation of V2G in charging station. The Smart Meter keeps track of the power transaction between EV and grid. The EVs connected to the charging station with

wireless access support for EV to smart meter is shown in Fig.1.

The On-Board communication unit of EV is responsible for communication with aggregator or smart meter or another EV. In this paper we use the term EV to Smart Meter instead of On-Board communication unit of EV. The EVs are usually parked in the residential apartment or office building. The charging slots are provided in parking station in indoor wireless environment. Both EV and Smart Meter are fixed entities and the people moving around will influence the wireless channel. The Smart Meter acts as an interface between the EV and Grid Control Center (GCC). The power transaction between EV and the Grid is tracked by the Smart Meter and the tariff at that point of time is communicated to the EV owner.

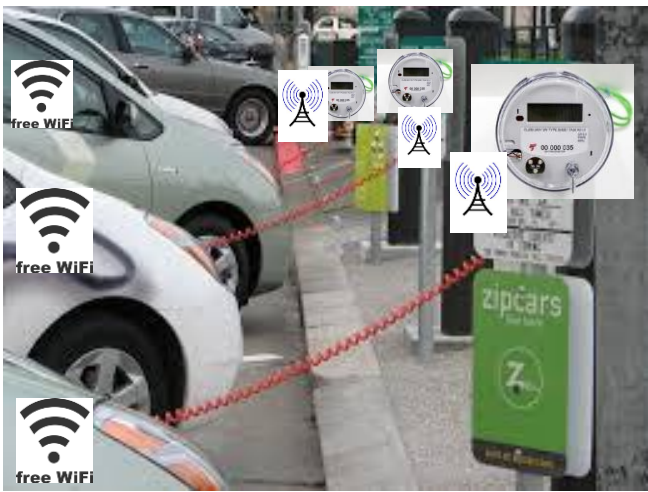

Fig. 1. EV to smart meter communication in V2G.

2. Background

The various opportunities and challenges of V2G are presented in [6] and the existing techniques available for V2G integration are reviewed in and the potential economic benefits of V2G are listed [4]. The basics of V2G and the revenue generation associated with it are presented in [1] and the complexities involved in implementation of V2G are explained in [2]. The detailed conceptual frame work of V2G is presented in [8] and contactless charger suitable for Indian Power Grid environment and benefits are projected in [9].

The communication between the grid control center and aggregator is presented in [10,11,12] and the communication between the aggregator and EV is discussed in [10,13,14].The integration EVs into Smart Grid is presented in [15]. There is no mention of wireless access support for EV to Smart Meter communication in V2G. The WiFi protocol is proposed for grid EV to Smart Meter communication in V2G. The physical

layer of WiFi protocol is modeled using MATLAB/SIMULINK and its performance is investigated.

3. Fading Channels

The channel model is a mathematical representation of the relation between the transmitted and received power during transmission in wireless communication. The channel model describes the effects of channel on the transmitted signal. The fading leads to variations in the transmitted signal during propagation over time and frequency. The fading occurs due to large scale and small scale fading. The path loss and shadowing fall in the large scale fading category. The multipath is responsible for small scale fading[16,17].

The large scale fading occurs due to the path loss and shadowing. The path loss occurs due to the large distance travelled by the transmitted signal and the shadowing occurs due to the obstacles, building, trees, hills and walls. The variations in the transmitted signal due to the large scale and small scale fading are shown in Fig.2.

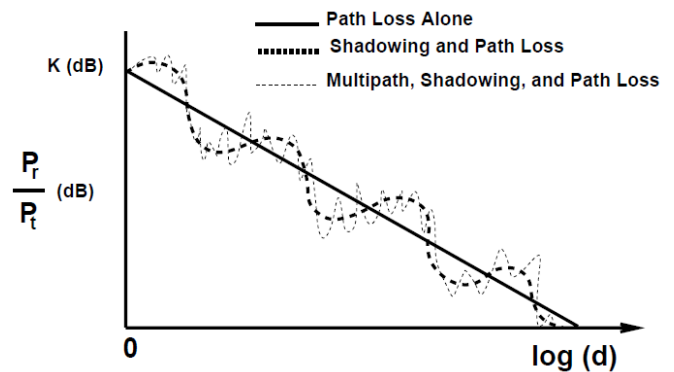

Fig. 2. Variations in the signal due to path loss, shadowing and multipath.

The indoor wireless channels have different fading characteristics compared to the mobile case. The transmitter and receiver in these system are stationary and people move in between and influence the channel. In case of outdoor mobile systems the user is moving through an environment [19]. For the indoor environment, the effect of fading can be described using Doppler spectrum:

$$S(f) = \frac{1}{1 + A \left(\frac{f}{f_d} \right)^2} \tag{1}$$

where A defines the 0.1 S(f) at frequency f_d.

$$(S(f)) \Big|_{f=f_d} = 0.1, \text{ so, } A = 9 \tag{2}$$

The Doppler spread f_d is defined as

$$f_d = \frac{v_o}{\lambda} \quad (3)$$

where v_o is environmental speed (based on measurements) and λ is wavelength and is given by:

$$\lambda = \frac{c}{f_c} \quad (4)$$

where c represents light speed, f_c carrier frequency, f_{max} maximum frequency component of Doppler spectrum and it limits the range of frequencies(upper bound). Usually, $f_{max} = 5 f_d$.

The channel models are developed for wireless local area network (WLAN). The bandwidths up to 100MHz at frequencies of 2 and 5GHz are considered. There are set of six profiles A to F and cover flat fading, residential, small office, typical office, large office/ large space (indoor/outdoor) scenarios. The path loss model and shadowing are available for each channel model. The MIMO multipath fading channel also exists for describes the multipath delay profile, spatial properties, K-factor distribution and Doppler spectrum [20].

The MIMO technique use multiple antennas both at the transmitter and receiver sides to improve the performance of the communication. It addresses the issue of multipath, exploits space dimension and improves system capacity, range and reliability. The data throughput is increased without additional bandwidth and increased transmitted power. The fading is reduced and spectral efficiency is increased. The Table 1 depict the different types of antenna viz. SISO/SIMO/MISO/MIMO [21].

Table 1. Types of Antenna

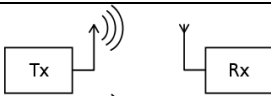
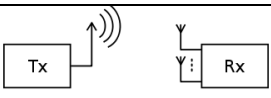
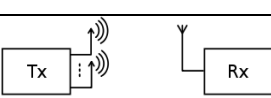
Antenna types		
SISO	One antenna at transmitter and receiver side.	
SIMO	One antenna at transmitter side and multiple antennas at receiver side.	
MISO	Multiple antennas at transmitter side and one antenna at receiver side.	

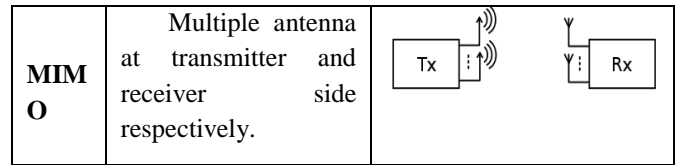

The MIMO channel matrix H for each tap at particular instance of time can be separated into a fixed (LOS) matrix and a Rayleigh (NLOS) matrix. The 4X4 MIMO is example is considered

$$H = \sqrt{P} \left(\sqrt{\frac{K}{K+1}} H_f + \sqrt{\frac{1}{K+1}} H_v \right)$$

$$= \sqrt{P} \left(\sqrt{\frac{K}{K+1}} \begin{bmatrix} e^{j\phi_{11}} & e^{j\phi_{12}} & e^{j\phi_{13}} & e^{j\phi_{14}} \\ e^{j\phi_{21}} & e^{j\phi_{22}} & e^{j\phi_{23}} & e^{j\phi_{24}} \\ e^{j\phi_{31}} & e^{j\phi_{32}} & e^{j\phi_{33}} & e^{j\phi_{34}} \\ e^{j\phi_{41}} & e^{j\phi_{42}} & e^{j\phi_{43}} & e^{j\phi_{44}} \end{bmatrix} + \sqrt{\frac{1}{K+1}} \begin{bmatrix} X_{11} & X_{12} & X_{13} & X_{14} \\ X_{21} & X_{22} & X_{23} & X_{24} \\ X_{31} & X_{32} & X_{33} & X_{34} \\ X_{41} & X_{42} & X_{43} & X_{44} \end{bmatrix} \right) \quad (5)$$

where X_{ij} (i^{th} receiving antenna and j^{th} transmitting antenna), K is Ricean factor and P is tap power [19].

4. WI-FI Protocol for Smart Meter to EV Communication

The EV is connected to the grid and takes part in power transaction. The Smart Meter keeps track of power transaction between the vehicle and grid. EVs are concerned about State of the Charge (SOC) of battery, charging and parking slot. One EV connected to the grid seems to be trivial issue but group of EVs certainly make sizeable difference. The group of EVs can be connected to the grid for power transaction and support the grid in meeting load demands. The communication support for the Smart Meter and the EV is very important as it plays a prominent role in V2G operation. The Wi-Fi protocol is proposed for smart meter to EV communication. The block diagram of physical layer of Wi-Fi protocol (SISO) is shown in Fig.3.

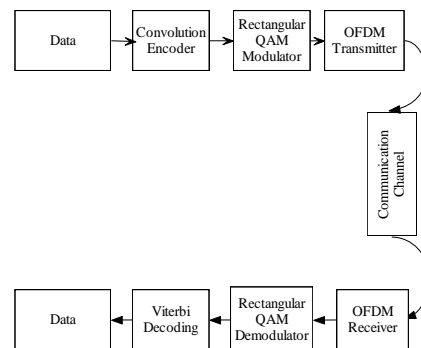

Fig. 3. Block diagram of Wi-Fi (SISO) physical layer.

The OFDM eliminates ISI caused due to multipath with the help of longer symbol periods and a cyclic prefix. Unlike single carrier system, to achieve higher data rates it does not

require increased symbol rates. The cyclic prefix (CP) and the FFT period are two components of OFDM symbol. The Fig.4 shows the OFDM symbol period (longer) and cyclic prefix to eliminate the ISI [22]. The WiFi is based on the OFDM technology and helps to tackle the ISI. The disadvantages of OFDM are: highly sensitive for frequency offset and high peak-to- average power ratio (PAPR).

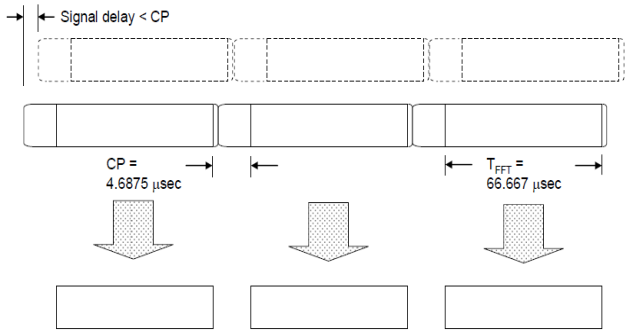

Fig. 4. OFDM frame.

5. Simulation Results

The indoor wireless channel models B and C are considered for simulation as they are specific to residential and small office scenarios. The EVs are usually parked in the basement of the office building or residential apartment. The indoor environment is assumed for EV parking and charging to facilitate theV2G operation.

Each model comprises of clusters and they are assigned to set of spatial properties: i) mean angle of arrival (AoA) ii) mean angle of departure (AoD), iii) angular spread (AS) at transmitter and receiver. The parameters have same values for all the tap delays for a given cluster and they determine the transmit and correlation matrices for each tap delay. The parameters for channel model are taken from the standard reference [19, 20]. The 2X2 MIMO (2 transmit antenna and 2 receive antenna) is considered for simulation.

The Doppler effect is different from other typical mobile cellular models and can be chosen for the fading characteristics(indoor wireless channel model). The Doppler spectrum is estimated from the complex path gains for Tx1-Rx1 link of the first path. The Fig.5 and Fig.6 depict that the obtained Doppler spectrum fits the theoretical values. For each transmit-receive link, the fading envelope waveforms are shown in Fig.7, Fig.8, Fig.9 and Fig.10 respectively for the channel model B which is developed for the residential environment[20,21]. The results demonstrate that the signal get faded at different intervals and for different combination.

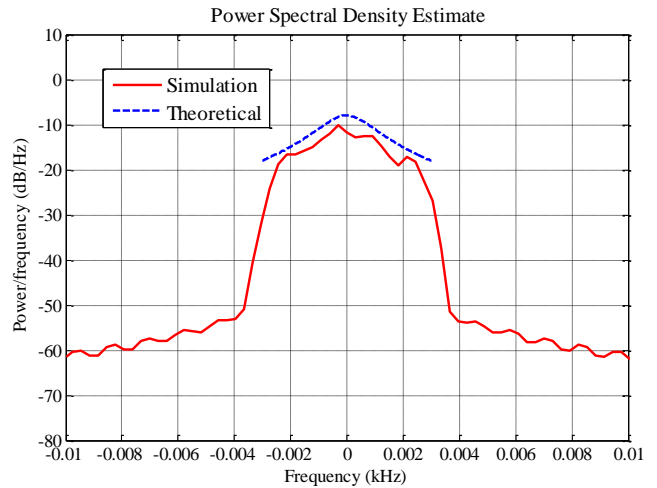

Fig. 5. Doppler spectrum estimate.

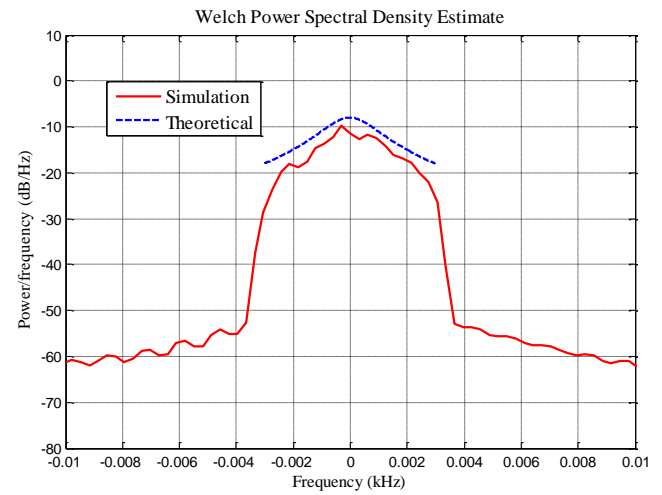

Fig. 6. Doppler spectrum estimate.

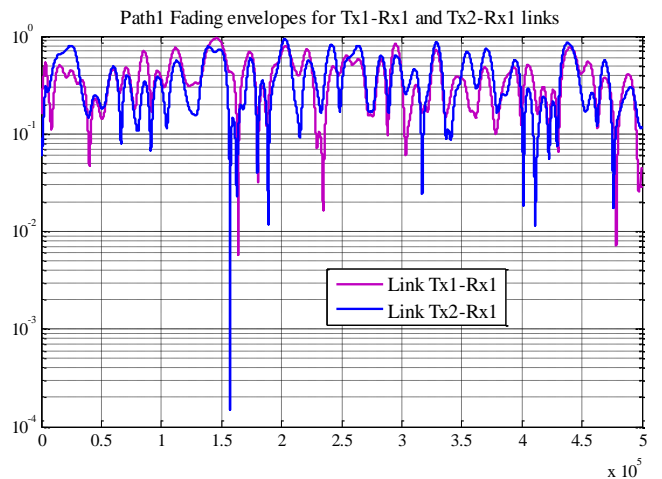

Fig. 7.Path1 Fading Envelopes for Tx1-Rx1 and Tx2-Rx2 links.

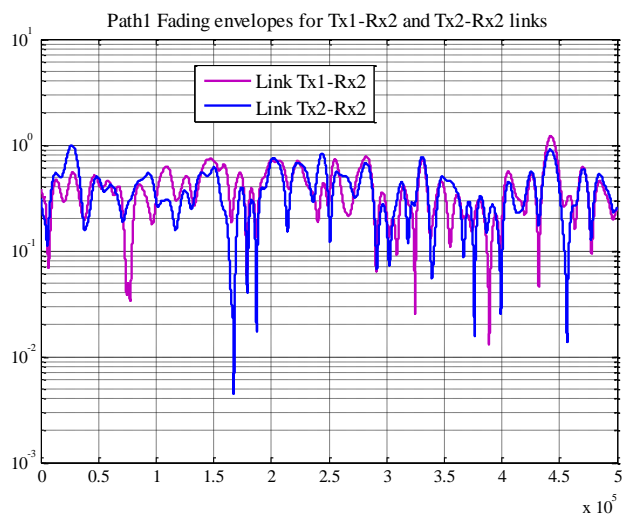

Fig. 8. Path1 Fading Envelopes for Tx1-Rx2 and Tx2-Rx2 links.

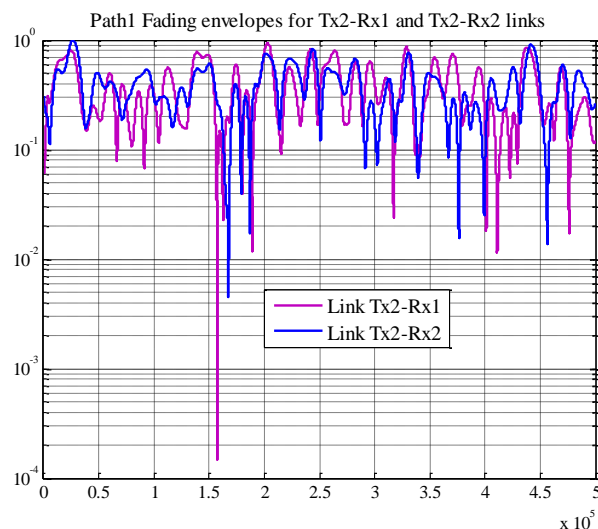

Fig. 10. Path1 Fading Envelopes for Tx2-Rx1 and Tx2-Rx2 links.

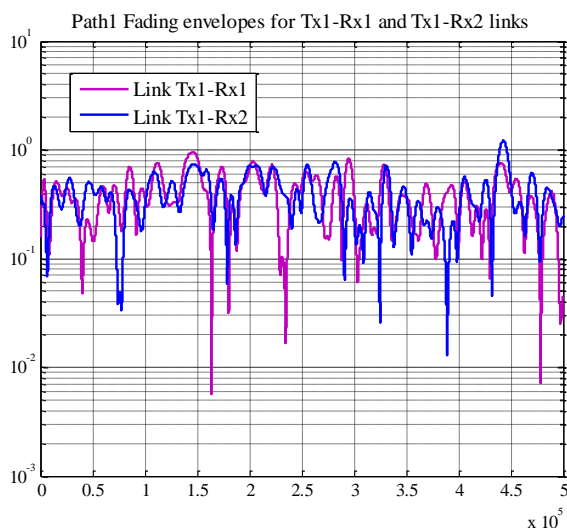

Fig. 9. Path1 Fading Envelopes for Tx1-Rx1 and Tx1-Rx2 links.

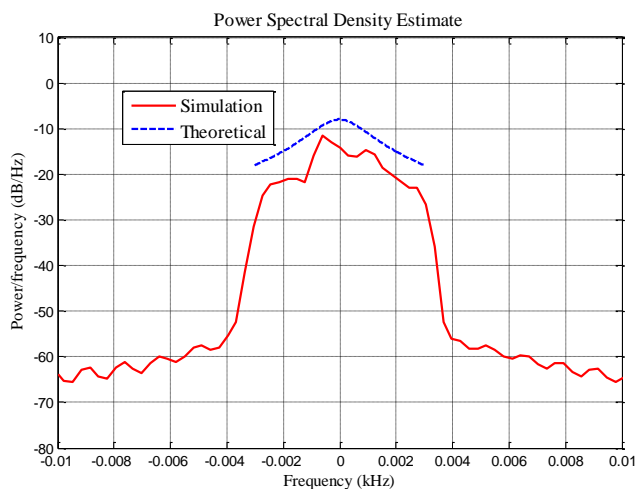

Fig. 11. Doppler spectrum estimate.

The Fig.11 and Fig.12 depict that the obtained Doppler spectrum fits the theoretical values. The fading envelope waveforms for each transmit-receive link are shown in Fig.13, Fig.14, Fig.15 and Fig.16 respectively for the channel model C which is developed for the residential / Office building environment.

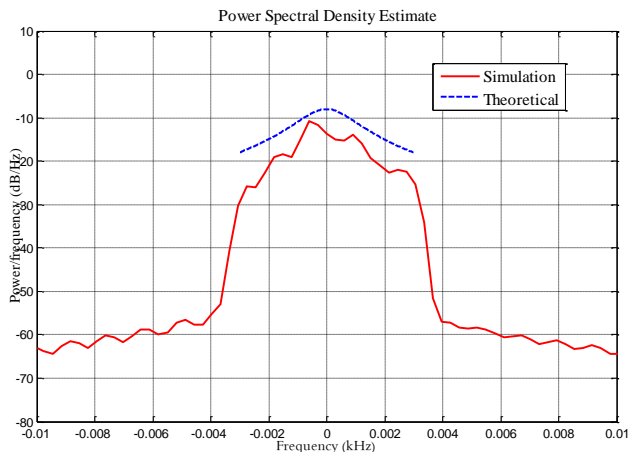

Fig. 12. Doppler spectrum estimate.

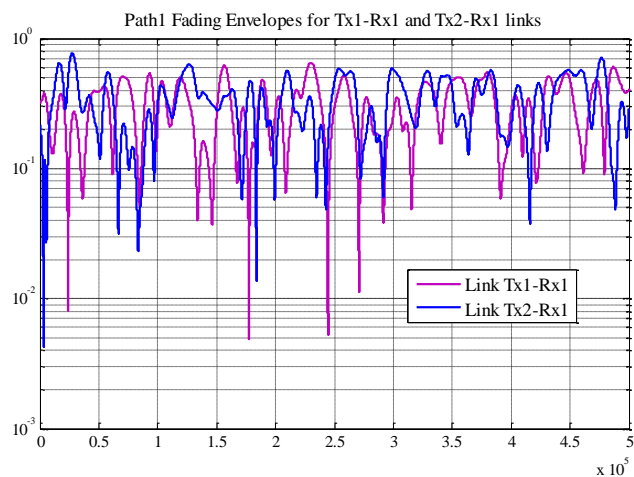

Fig. 13. Path1 Fading Envelopes for Tx1-Rx1 and Tx2-Rx1 links.

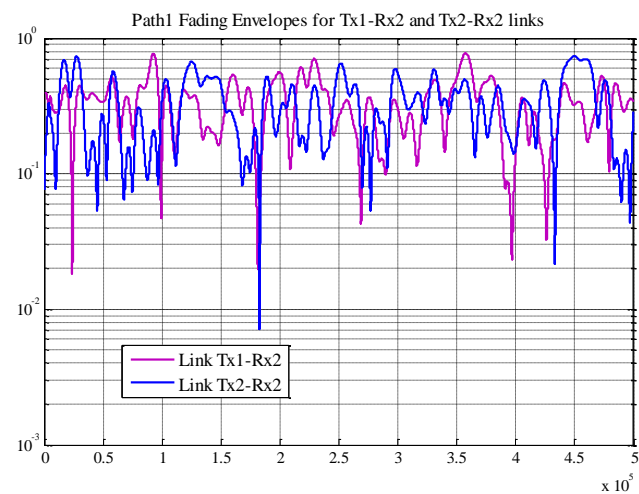

Fig. 14. Path1 Fading Envelopes for Tx1-Rx2 and Tx2-Rx2 links.

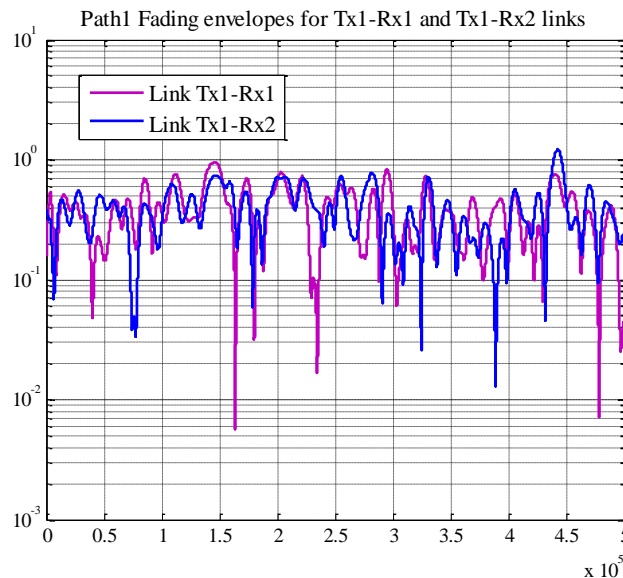

Fig. 15. Path1 Fading Envelopes for Tx1-Rx1 and Tx1-Rx2 links.

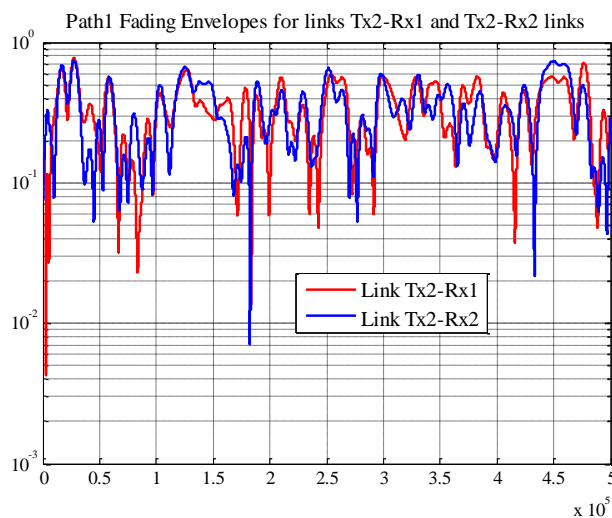

Fig. 16. Fading Envelopes for the links Tx2-Rx1 and Tx2-Rx2 for path 1.

The simulation parameters for WiFi (SISO) are shown in Table 2. and is simulated for $F_s=20\text{MHz}$, $N=64$, $L=16$, center frequency $F_C=5.0\text{ GHz}$, $v=50$, Doppler frequency $F_D=v*F_C$, delay $\tau=[0, 0.1, 0.4]*1e-6$, path gain $P=[0, -2, -4]$. The bit error rate (BER) v/s signal-to-noise ratio (SNR) plot is shown in Fig.17. Fig.17 shows that to achieve BER of 10^{-1} the 16 QAM (Quadrature Amplitude Modulation) requires 26dB and 64 QAM requires 32dB. The 64 QAM with coding rate $\frac{1}{2}$ to achieve BER less than 10^{-1} requires 20dB.

Table 2. Parameters for 802.11

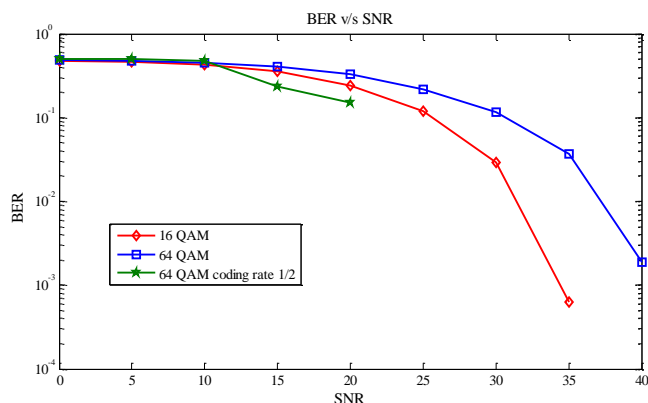

Fig. 17. BER v/s SNR.

6. Conclusion

The wireless communication link is established between EV and the Smart Meter in indoor wireless environment. The Doppler model is considered specifically for this case as both the transmitter and receiver entities are fixed. The power transaction between the EV and Grid are tracked by the Smart Meter and corresponding tariff related information is communicated to the EV owner. The channel models for indoor wireless communication specifically for residential apartment and office building environment are simulated as the EVs are parked in these locations. Also, the physical layer of WiFi protocol is modeled in MATLAB/SIMULINK. The BER v/s SNR curve is plotted and the performance of the WiFi protocol is investigated. The EV to the Smart Meter communication infrastructure is developed in order to increase the safety and the performance efficiency of V2G.

References

[1] Willett Kempton; Jasna Tomić, "Vehicle-to-grid power implementation: From stabilizing the grid to supporting large-scale renewable energy", Elsevier Journal of Power Sources, vol. 144, no. 1, pp. 280-294, June 2005.

[2] Willett Kempton; Jasna Tomić, "Vehicle-to-grid power fundamentals: Calculating capacity and net revenue", Elsevier Journal of Power Sources, vol.144, no.1, pp. 268-279, June 2005.

[3] Z. Wang; S.Wang, "Grid Power Peak Shaving and Valley Filling Using Vehicle-to-Grid Systems," IEEE Trans. Power Delivery., vol. 28, no. 3, pp.1822–1829, July 2013.

[4] Yilmaz, M.; Krein, P.T., "Review of the Impact of

Parameters	WiFi Protocol
Bit rate Mbits/sec	6, 9, 12, 18, 24, 36, 48, 54
Modulation code	16-QAM, 64-QAM
Code rate	1/2
Number of Subcarriers	52
Symbol duration in micro sec	4
Guard time in micro sec	0.8
FFT period in micro sec	3.2
Preamble duration in micro sec	16
Subcarrier spacing MHz	0.3125

Vehicle-to-Grid Technologies on Distribution Systems and Utility Interfaces," Power Electronics, IEEE Transactions on, vol.28, no.12, pp.5673, 5689, Dec. 2013.

[5] Diyun Wu; Chunhua Liu; Shuang Gao, "Coordinated Control on a Vehicle-to-Grid System" , in IEEE Conference, 2010.

[6] Chunhua Liu; Chau, K.T.; Diyun Wu; Shuang Gao,"Opportunities and Challenges of Vehicle-to-Home, Vehicle-to-Vehicle, and Vehicle-to-Grid Technologies," Proceedings of the IEEE, vol.101, no.11, pp.2409, 2427, Nov. 2013.

[7] Santoshkumar; Udaykumar R.Y, Swapna M., "Modeling and Architectural Frame Work of Off-Board V2G Integrator for Smart Grid", International Journal of Renewable Energy Research,vol.4, no.4,pp.826-831,Dec.2014.

[8] Christophe Guille; George Gross, "A conceptual framework for the vehicle-to-grid (V2G) implementation", Elsevier Energy Policy, vol.37, no.11, pp. 4379-4390, November 2009.

[9] Thirugnanam. K, Joy. T.P.E.R, Singh. M, Kumar. P, "Modeling and Control of Contactless Based Smart Charging Station in V2G Scenario", IEEE Transactions on Smart Grid, vol.5, no.1, pp.337, 348, Jan. 2014.

[10] E. I. Zountouridou; G.C.Kiokes; N.D.Hatziargyriou; N.K.Uzunogle, "An Evaluation Study of Wireless Access Technologies for V2G Communications", 16th International Conference on Intelligence System Applications to Power Systems, Crete, Greece, 2011.

[11] Santoshkumar; Udaykumar R.Y, "IEEE 802.16-2004 (WiMAX) Protocol for Grid Control Center and Aggregator Communication in V2G for Smart Grid Application", IEEE international Conference on Computational Intelligence and Computing Research, Madurai, India (2013).

[12] Santoshkumar; Udaykumar R.Y, "Modeling and Comprehensive Analysis of WiMAX Protocol for Grid

- Control Center to Aggregator Communication in Vehicle-to-Grid (V2G)", accepted for publication in International Journal of Renewable Energy Research.
- [13] Santoshkumar; Udaykumar R.Y., Performance Investigation of Mobile WiMAX Protocol for Aggregator and Electrical Vehicle Communication in Vehicle-to-Grid(V2G)", IEEE Canadian Conference on Electrical and Computer Engineering, Toronto, Canada (2014).
- [14] Massimo Conti; Dario Fedeli; Marco Virgultil, "Bluetooth(B4V2G) for Electrical Vehicle to Smart Grid Connection", IEEE Intelligent Systems in Embedded Systems, pp. 13-18 (2011).
- [15] Kovacs A; Marples D; Schmidt; R., Morsztyn R; "Integrating EVs into the Smart-Grid", 13th International Conference on ITS Telecommunications (ITST), pp. 413 – 418 (2013).
- [16] Mohammad Shahajahan; A. Q. M. Abdulla Hes-Shafi, "Analysis of Propagation Models for WiMAX at 3.5 GHz", Masters Thesis, Blekinge Institute of Technology, September(2009).
- [17] Josip Milanovic; Rimac-Drlje S; Bejuk K, "Comparison of propagation model accuracy for WiMAX on 3.5GHz", IEEE International conference on electronic circuits and systems, Morocco(2007).
- [18] V.S. Abhayawardhana; I.J. Wassel; D. Crosby; M.P. Sellers; M.G. Brown, "Comparison of empirical propagation path loss models for fixed wireless access systems", IEEE Technology Conference, Stockholm(2005).
- [19] IEEE P802.11 Wireless LANs, "TGn Channel Models", IEEE 802.11-03/940r4, 2004-05-10.
- [20] <https://mathworks.com>
- [21] <http://djj.ee.ntu.edu.tw/MIMO.docx>