

# Improved Voltage Control Methodology for Smart Distribution System with Dispersed Generation

VSB Chaitanya Duvvury\*<sup>‡</sup> , Rayudu K\*\* 

\*Assistant Professor, Department of EEE, BV Raju Institute of Technology (Autonomous), Narsapur, Medak District, Telangana - 502313, India.

\*\*Professor, Department of EEE, BV Raju Institute of Technology (Autonomous), Narsapur, Medak District, Telangana - 502313, India.

(chaitanya.d@bvrit.ac.in, rayudu.katuri@bvrit.ac.in)

<sup>‡</sup>Corresponding Author; VSB Chaitanya Duvvury, 502313, Tel: +91-9933670003, Chaitanya.d@bvrit.ac.in

*Received: 07.09.2022 Accepted: 07.10.2022*

**Abstract-** The inclination of distribution networks towards increased penetration of Distribution Generation (DG) has caused major operational challenges in control of distribution systems, where voltage control is one of influencing factor. In this context, an improved voltage control methodology is proposed to handle voltage control problem in such distribution networks. The proposed methodology works on the basis of calculations performed by Remote Terminal Units (RTU) placed at each DG. The RTUs at each DG will coordinate with each other to obtain the voltage profile of DG influenced feeder. Also, the proposed methodology is independent of loading conditions and R/X ratio of line. Various simulations have been performed using MATLAB environment to show the effectiveness of proposed methodology for single and multiple feeders.

**Keywords** Distribution generation, Remote terminal units, Distribution networks, Voltage control, Simulation.

## 1. Introduction

Adaptive operation of Distribution Systems at recent times has become quite challenging due to increased dominance of Distributed/Dispersed Generation (DG) installed at the consumer end. DG installation is highly influenced due to depleting conventional reserves, demand growth and wide expansion of electrical network causing more conduction loss [1, 2]. Traditional distribution systems were prior designed keeping in view of centralized power generation where power always flows from generation end to consumer premises, but due to installation of DGs at consumer end, power generation has become decentralised where power flow becomes bidirectional depending on generation and load at the point of time considered. In this regard, distribution system often experiences typical operating conditions where relevant control measures/procedures are to be precisely developed for the purpose. Development of Distribution Automation (DA) functions through intelligent control is one of promising option to resolve this issue. Assimilation of DA with DGs in Distribution system will evolve to Smart Distribution Systems which are potent by itself, thereby, necessary control actions can be taken care of inherently within the system [3, 4]. Distributed Generation capacity can range from hundred to few thousands of watts being either dispatchable or non-dispatchable, influenced by seasonal, time and location

factors. Although installation of DGs results in increased reliability, reduction of peak requirements in grid, reduced emissions, and many [5]. Besides to that DG penetration will rise issues like, voltage control, reverse power flow, harmonics, increased losses and increased short circuit levels which are the major concern in deciding the location and capacity of DG [5-8]. Considerable solutions have been proposed in the literature on voltage control problem and on how to maintain voltage profile of feeder within the limits, that arise due to improper penetration of DG. Conceptually these proposed ways can be grouped in to Centralized and Decentralized approaches [9]. In order to handle the problem of steady state voltage rise in DG installed distribution feeder, the voltage profile along the entire feeder must be known to take necessary action. Since the voltage profile is highly influenced by uncertain generation and load, real time estimation of voltage profile is a big challenge. This estimation can be made by placing Remote Terminal Unit (RTU) at certain locations along the feeder, but it necessitates robustly designed communication network among the RTUs in the system. It can be done by having a well-defined Advanced Metering Infrastructure (AMI) [10] equipped in the system. Thus, the proposed methodology is implemented on the basis of mutual communication among RTUs [11-13], thereby the voltage profile estimation can be made along certain feeder or entire network. In [14], the voltage control

problem has been formulated to find the optimal setting for the certain time horizon, but it is difficult to implement in real time. In [15], the voltage controller which take in to effect of DG based on local measurements within the controller location was proposed, but it is highly independent on the DG operating behaviour in the feeder section. In [16], a coordinated voltage control scheme for online control of voltage in distribution networks with DG is proposed. This approach is based on information obtained from distant RTUs. Also, in [17-19] similar implementation was made but with limited calculation and measurement information. But these schemes assume that line impedance of any section is always constant, however in practice this is not valid [16, 19] and R/X values are not constant along the line. In [18], eventhough the assumption of R/X has not been taken in to account, but RTUs are placed at other points including at DG bus.

The proposed method assumes that proper voltage regulating device such as On-Load Tap changer was installed at the root bus such that after receiving the relevant information from feeder RTUs, the root bus central controller will initiate the necessary action thereby voltage along the entire feeder will be controlled and will be within the specified limits. In this paper, an improved methodology of [16] without considering any assumption regarding the line impedance is proposed. This method implements the same basic dataflow between RTUs as proposed in [16], but the estimation methodology is modified and generalized, that can be applied to any smart distribution system with many laterals and with any number of DGs on each lateral. The paper is organised as follows: Section 2 details about the basic problem of voltage rise with DG in feeder and its counter effects. Section 3 describe the Voltage profile evaluation phenomenon applied in this proposed methodology and feasible condition of solution. Section 4 describe about the approach and methodology proposed. In Section 5 the simulated results of proposed methodology on different sample distribution systems were presented. Section 6 gives the discussions and conclusions made.

**2. Voltage Variation on Feeder With DG**

A DG connected to the feeder injects power from that bus and causes voltage at that bus to rise (Assuming it will always inject either P/Q or both). Also, this injected power will flow in any direction depending on generation and load scenario at that point of time, so the voltage along the feeder will now be depending on various factors such as R/X ratio, amount of injected power and load [20]. This can be validated by a two-bus distribution system with voltages and impedance as shown in Fig.1 which is influenced by load, DG and compensation equipment at one end. The suffix for powers G, L and C refers to Generation, Load and Compensation respectively. From Fig.1, we can write,

$$V_1 - V_2 = (R + jX) * \frac{(P_L - P_G) - j(Q_L - Q_G - Q_C)}{V_2^*} \tag{1}$$

Since R/X ratio of distribution network is high, the imaginary part of Eqn. (1) can be neglected in net expression (1), the resulting equation in per unit will be,

$$\Delta V = V_1 - V_2 = R(P_L - P_G) + X(Q_L - Q_G - Q_C) \tag{2}$$

Now depending on amount of power injected by DG, the above Eqn. (2) can have any sign and magnitude. If DG real power injection is more than load and net reactive power injection also more than load demand, V2 will become greater than V1 and can cause voltage rise problem. Hence, proper coordination is required to have an acceptable voltage profile along the feeder [20]. Also, according to quadratic equation proposed in [21], as given in Eqn. (3), where P and Q are the net power carried by the line in given direction,

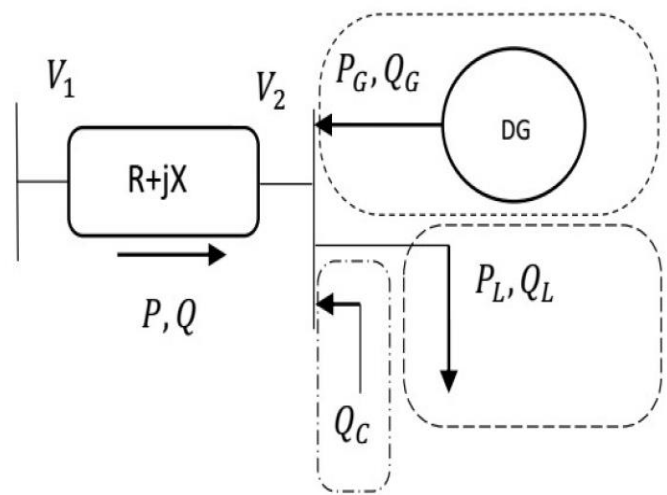

Fig.1. Two bus system with Load, DG, and capacitor

$$V_2^4 + (2PR + 2QX - V_1^2)V_2^2 + (R^2 + X^2)(P^2 + Q^2) = 0 \tag{3}$$

Expressing Eqn.(3) in terms of p.u., and neglecting the third term. Upon simplification and assuming V1 + V2 ≈ 2, it finally reduces to

$$V_1 - V_2 = PR + QX \tag{4}$$

which is similar to Eqn. (2), when net power carried in given direction is expressed in terms of load, generation, and shunt compensation.

**3. Evaluation of Voltage Profile**

Based on discussion in Section 2., the voltage profile will change along the feeder where DG is installed and there will be chances where voltage at certain points will reach to unacceptable limits. For that, evaluation of voltage along the feeder is made using certain automation devices installed at specific points in the systems. In the present context as suggested in [16], Remote Terminal Units (RTU) were

installed at DG buses there by which voltage profile can be better estimated. In [16], certain results were proved for the existence of maximum and minimum voltage along the feeder. Moreover, they are based on assumption that R/X ratio has to be constant along any line section. Here in proposed methodology, the same estimation procedure is followed but the methodology to get the voltage profile of feeder was modified without taking any assumption regarding R/X ratio of line section. Considering the part of distribution system, where two DGs are connected to a load which is more or less halfway between DGs, as shown in Fig. 2. Then, the value of expected minimum voltage between two DGs as calculated from DG1 end is obtained as,

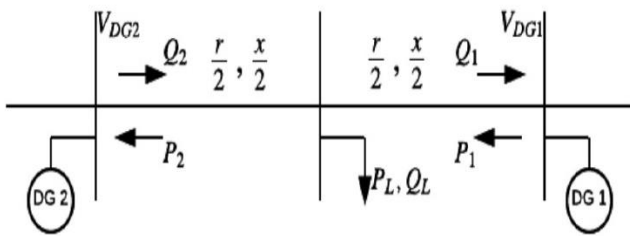

Fig.2. Voltage evaluation method

$$V_{min,DG1} = V_{DG1} - (P_1 \frac{r}{2} - Q_1 \frac{x}{2}) \quad (5)$$

Similarly, the value of expected minimum voltage between two DGs as calculated from DG2 end is obtained as,

$$V_{min,DG2} = V_{DG2} - (-P_2 \frac{r}{2} - Q_2 \frac{x}{2}) \quad (6)$$

Now the better estimate can be obtained from average of Eqn. (5) and Eqn. (6),

$$V_{est,avg} = \frac{V_{min,DG1} + V_{min,DG2}}{2} \quad (7)$$

This estimation procedure is made by each RTU and it will update it to the preceding RTU, thereby the net estimated values reach to the central controller where the final necessary control action can be initiated.

**4. Voltage Control Methodology**

The preceding section dealt the voltage evaluation phenomenon based on the data obtained from the RTU. Hence, we confirm that RTU and its associated communication infrastructure place a crucial role in this voltage control methodology. A Remote Terminal Unit is an electronic device that is normally controlled by a processor which is interfaced with physical objects to a Distributed Control System (DCS) or Supervisory Control and Data Acquisition (SCADA) system by transmitting telemetry data to the system [22], [25-30]. Here in this methodology, RTUs are placed at buses where DGs are connected (since those buses will suffer from transitory changes in voltage). Fig. 3

depicts the distribution system with more laterals, and each lateral being influenced with DG. Each DG unit is associated with an RTU where it will fetch some data at the connected bus and performs some mathematical operations and send the processed data to higher end RTU (in direction towards grid). This procedure is repeated with all the RTUs where the final data will reach to the Central Controller connected to the grid. These final data will have the estimated values of minimum and maximum voltages of considered feeder and entire voltage profile of feeder, where this makes the necessary data required to initiate the control action by the Central controller.

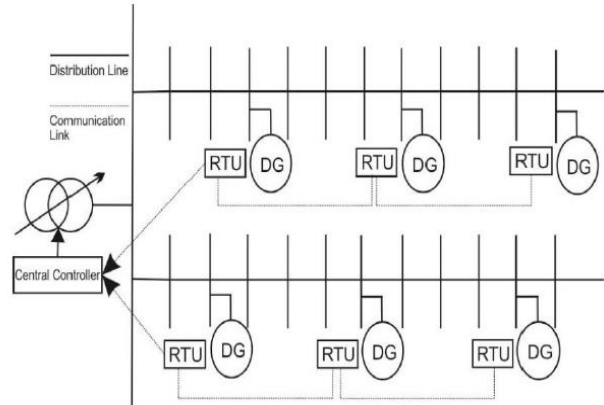

Fig.3. Distribution system structure with RTU at each DG

Fig. 4 shows the values to be fetched by each RTU installed at DG. Each RTU at each DG is responsible to have such data to perform certain calculations based on the obtained measurements. These calculated values must reach to the higher end RTU and they should be done by each RTU. This can happen when there is an established communication link between all RTUs and the central controller.

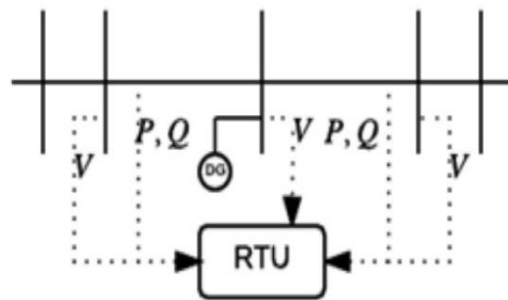

Fig.4. RTU measurements at each DG

Each RTU will fetch the following data at connected bus [16].

1. Voltage at DG connected bus  $V_m$  if DG is connected to bus 'm'.
2. Voltages at either side buses of bus 'm',  $V_{m+1}$  and  $V_{m-1}$
3. Real and Reactive power flow in either side lines of DG connected bus,  $P_{m,m+1}, P_{m,m-1}; Q_{m,m+1}, Q_{m,m-1}$ .

The value of voltage will be affected if DG is connected at the bus. The proposed methodology works on the basis of series of computations and interactions among RTUs connected at each DG, finally the Central controller connected to the voltage regulator will get the necessary information about the feeder/system thereby it can initiate required control action. In the proposed methodology, the control action is restricted to the change of tap position based on present tapping position and information reached to the central controller. The proposed methodology is based on the fact that, the RTUs connected to each DG will perform the computations as given by flowchart depicted in Fig. 5 & continued in Fig. 6.

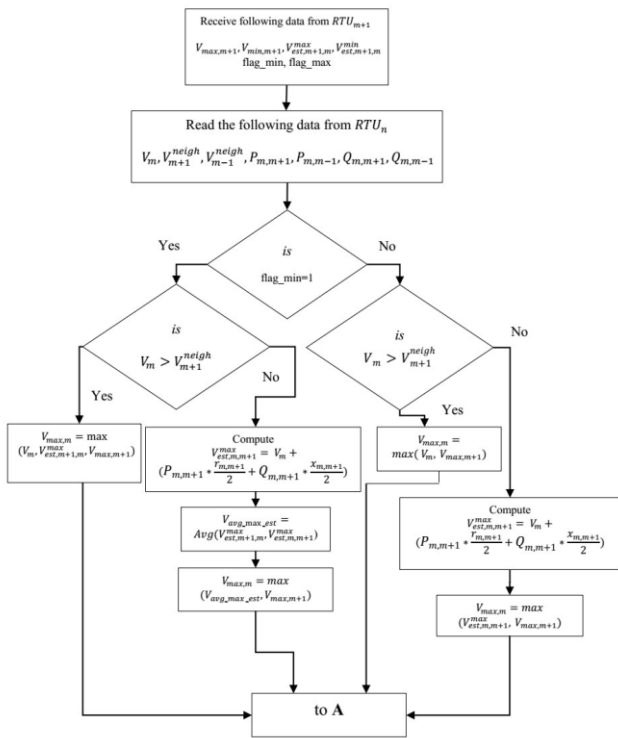

Fig.5. Flowchart for proposed methodology

Here RTU<sub>m+1</sub> refers to the RTU connected to distant DG at end side of feeder, RTU<sub>m</sub> refers to the considered RTU connected to m<sup>th</sup> bus DG in the feeder. The series of computations performed by the considered RTU<sub>m</sub> is based on information received from RTU<sub>m+1</sub> and data measured at connected bus i.e., m<sup>th</sup> bus. Here RTU<sub>m</sub> weighs the voltages at m<sup>th</sup> bus with that of its neighbouring buses to identify the trend of voltage around DG and estimates the voltage on either side of its buses by comparing with the ultimate values obtained from RTU<sub>m+1</sub>. Finally, RTU<sub>m</sub> calculates the minimum and maximum values up to m<sup>th</sup> bus of the feeder by refreshing the ultimate values obtained from RTU<sub>m+1</sub>. This methodology is based on the fact that each RTU compares the possibility of existence of either maximum or minimum voltage on the part of feeder considered. Depending

on the existing conditions RTUs will estimate the corresponding value based on the value from preceding RTU and with its own calculated value. This process is repeated and thereby consistently updating the maximum and minimum values of the voltage along the feeder. Now this RTU<sub>m</sub> will pass its calculated values to its upstream RTU i.e., RTU<sub>m-1</sub> and now RTU<sub>m-1</sub> will perform identical computations as done by RTU<sub>m</sub> for existence of either maximum or minimum voltages around the connected bus. This series set of computations will be performed by all RTUs until it reaches to the central controller where necessary control action is taken.

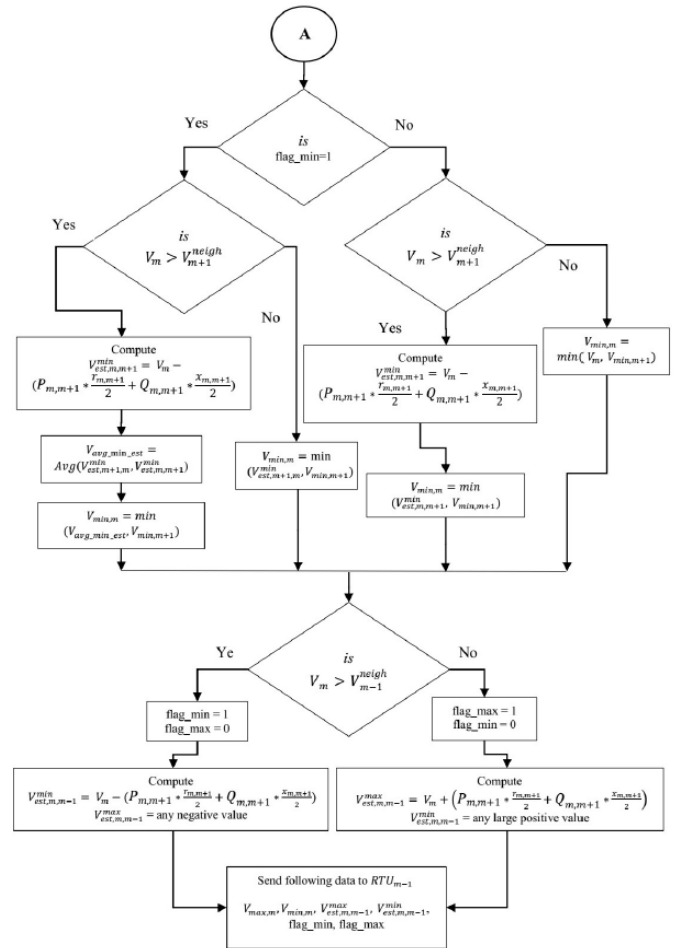

Fig.6. Flowchart for proposed methodology Contd.,

Ultimately the central controller will have maximum and minimum voltage of each feeder and the trend of voltage in the feeder. If single voltage regulator is installed at the grid end for all the feeders, then the proposed methodology work only if the condition given in Eqn. (8) is satisfied, if not another voltage regulator with enhanced settings is required for the purpose.

$$V_{feeders}^{max} - V_{feeders}^{min} < V_{perm}^{max} - V_{perm}^{min} \quad (8)$$

The voltage regulator will change its tapping based on Eqn. (9) which is reported in [23].

$$Tap_{new} = Tap_{old} + \frac{\left[1 + \frac{V_{feeders}^{max} - V_{feeders}^{min}}{2}\right] - V_{feeders}^{max}}{step} \tag{9}$$

**5. Simulation Results**

Various simulation results have been stated using MATLAB environment to justify the proposed methodology of voltage control scheme. Fig. 7 shows the considered 12 bus system with single feeder, the line parameters are given in [24] several cases are studied to justify the proposed methodology.

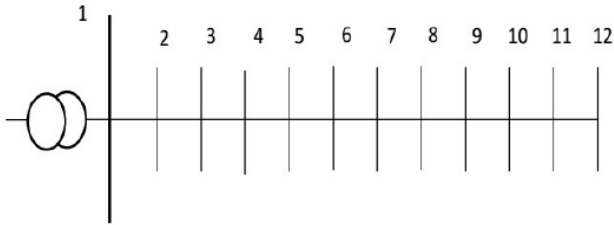

**Fig.7.** Sample 12-bus distribution system

Different load and generation levels are considered for the above system with single and double feeder configuration. In the considered system for all cases, the following data are assumed [16].

- Voltage regulator input voltage=1.0 p.u.
- Permitted maximum value of voltage =1.05 p.u.
- Permitted minimum value of voltage =0.95 p.u.
- Number of Tappings=33 (16 for upper 10%, 16 for lower 10%, and 1 for nominal)
- Tapratio=0.00625 p.u.

**Case 1:** In this case, single feeder configuration is considered with DGs at buses 4 and 9. DGs are considered with negative load, the system load and generation data are given in Table 1. With the given load and generation data at each bus, two RTUs at DGs has estimated the voltage profile according to the proposed methodology, and can be seen in Fig. 8. From Fig. 9 it is seen that the profile traced by the RTU is almost identical to that of actual voltage profile obtained from load flow [24] and has captured possible maximum and minimum voltages in the feeder.

From Fig. 8 it is clear that voltage profiles are out of allowable range, became minimum voltage of the system is less than 0.95 p.u. and hence voltage regulator should initiate its regulating action by changing the tap position calculated according to Eqn. (9) The voltage regulator will rise to tap setting 6 and bus 1 voltage will raise to 1.03515 p.u. After regulation, the voltage profile is improved and is as shown in Fig. 9, where the voltages are within the allowable range.

**Table 1:** Active and Reactive powers at each bus for Case 1

Bus No	P <sub>l</sub> (kW)	Q <sub>l</sub> (kVAr)	P <sub>g</sub> (kW)	Q <sub>g</sub> (kVAr)
2	60	60	-	-
3	40	30	-	-
4	50	55	105	0
5	50	30	-	-
6	70	45	-	-
7	85	85	-	-
8	45	45	-	-
9	50	55	90	85
10	85	40	-	-
11	80	60	-	-
12	25	25	-	-

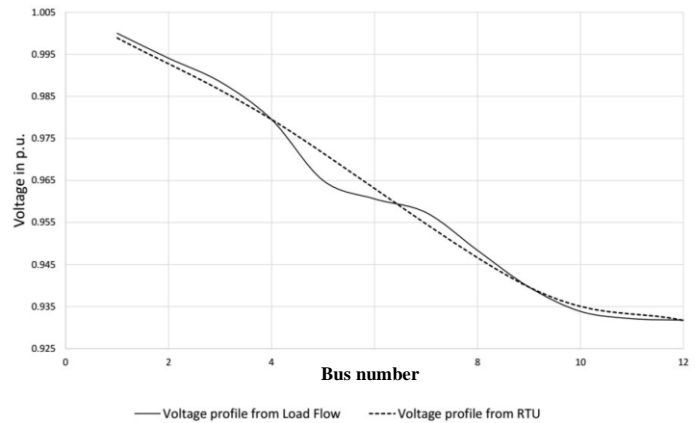

**Fig.8.** Case1 - Voltage profile from load flow and RTU

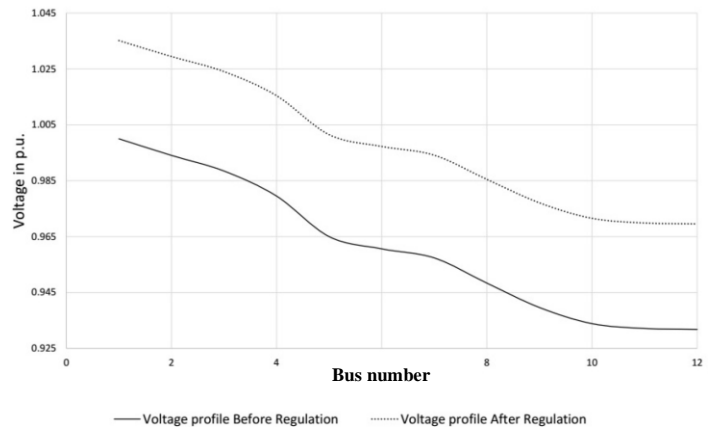
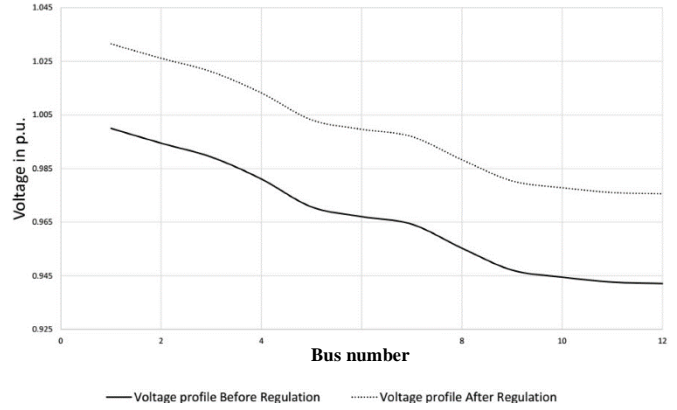

**Fig.9.** Case1 - Voltage profile after regulator action

**Case 2:** For this case, the same single feeder configuration is considered, but the positions of DGs and loadings at other buses are now changed. The system load and generation data for this case are given in Table 2. Similar to case 1, in this case also voltages were out to allowable range and regulator will initiate its action. The comparison of voltage profiles before regulation obtained from load flow and RTUs can be seen from Fig. 10. Here, the voltage regulator will rise to tap setting 5 and bus 1 voltage will raise to 1.0315 p.u. and voltage profiles after regulation can be seen from Fig. 11 where voltages are within the allowable range.

**Table 2:** Active and Reactive powers at each bus for Case 2

Bus No	P <sub>1</sub> (kW)	Q <sub>1</sub> (kVAr)	P <sub>1</sub> (kW)	Q <sub>1</sub> (kVAr)
2	60	60	-	-
3	40	30	-	-
4	50	55	-	-
5	40	30	60	0
6	40	45	-	-
7	55	55	-	-
8	55	45	-	-
9	50	40	-	-
10	55	40	80	70
11	80	30	-	-
12	45	15	-	-



**Fig.11.** Case2 - Voltage profile after regulator action

**Case 3:** Here, the 12-bus system has been configured with DG buses on feeder 1 and feeder 2 with line parameters of both feeders being the same, and two DGs were placed in each feeder with both feeders connected to same voltage regulator as shown in Fig. 12. The system load and generation data for this case are given in Table3 for both feeders F1 and F2.

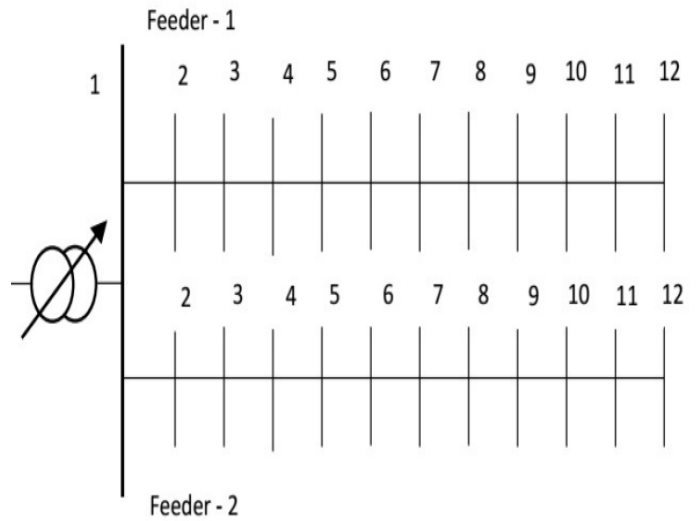

**Fig.12.** Double feeder system for Case 3

For this case, the voltage profiles from load flow and RTUs are shown in Fig. 13, from which it is inferred that voltage profiles of Feeder 1 are out of allowable range whereas that of Feeder 2 is within the range. Based on the obtained profiles, the voltage regulator will down its tap-to-tap position 5 and so voltage will down to 0.96885 p.u. and voltage profiles after regulation can be seen from Fig. 14, where changing of common tap position is affecting the voltage profile of Feeder 2 but not allowing to go beyond the allowable range.

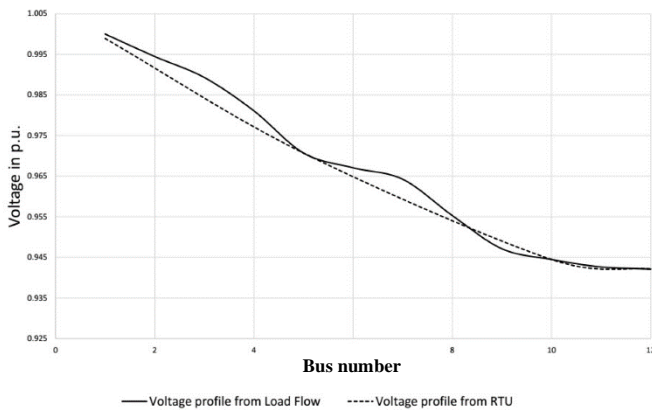

**Fig.10.** Case2 - Voltage profile from load flow and RTU

**Table 3:** Active and Reactive powers at each bus for Case 3 and 4

Bus No	P <sub>1</sub> (kW)	Q <sub>1</sub> (kVAr)	P <sub>1</sub> (kW)	Q <sub>1</sub> (kVAr)
F1 2	60	60	-	-
3	40	30	-	-
4	50	55	-	-
5	30	0	230	0
6	40	45	-	-
7	20	55	-	-
8	50	35	-	-
9	40	20	-	-
10	50	0	550	0
11	20	30	-	-
12	15	15	-	-
F2 2	90	60	-	-
3	40	30	-	-
4	30	55	85	0
5	40	40	-	-
6	50	45	-	-
7	45	45	-	-
8	55	45	-	-
9	30	0	440	0
10	50	30	-	-
11	80	30	-	-
12	45	15	-	-

**Case 4:** In this case with the same data as in case3 is considered, and to test the performance of the proposed methodology, the DG output powers are increased randomly to find the level of penetration up to which the current tapping position can able to maintain the profile within the allowable limits. By random increments in the output powers of all DGs, the maximum power that the DG can inject has been found. For DGs in Feeder 1, output powers can be up to 250 kW and

570 kW at buses 5 and 10 respectively, for DGs in Feeder 2, output powers can be up to 100 kW and 810 kW at buses 4 and 9 respectively. The voltage profiles before and after the changes in DG output powers can be seen in Fig. 15, where the voltages are within acceptable limits.

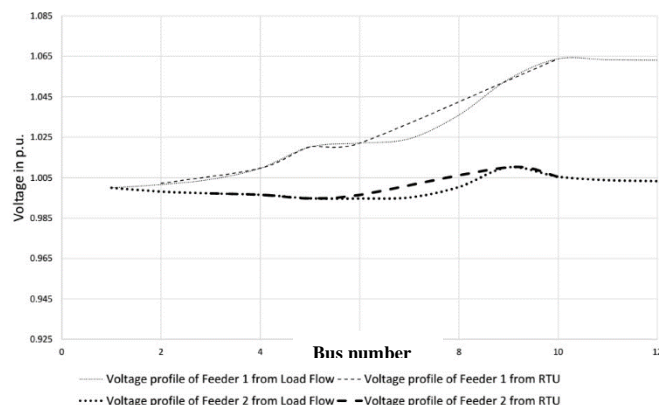

**Fig.13.** Case 3 - Voltage profile from load flow and RTU

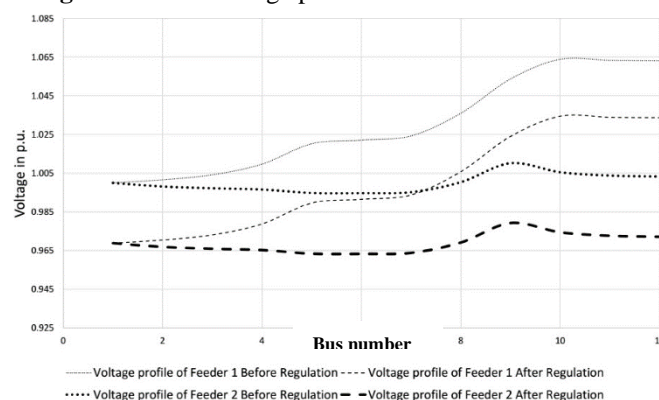

**Fig.14.** Case3 - Voltage profile after regulator action

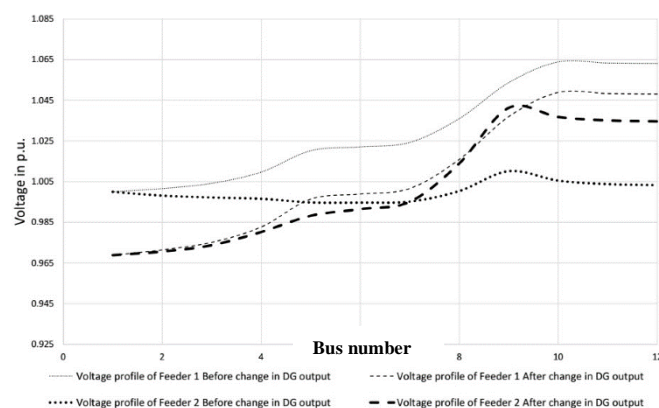

**Fig.15.** Case4 - Voltage profile before and after change in DG output power

## 6. Conclusions

An improved voltage control methodology has been proposed in this paper for smart distribution system to have acceptable voltage profile in the feeders influenced by Distributed Generation. The proposed methodology will work on the basis

of series of computations in RTUs with mutual communication thereby ascertaining the voltage profile by calculating the ultimate maximum and minimum voltage in feeder. The main feature of proposed methodology is that it is independent of R/X ratio of line section and also on position of DG, where each DG has one RTU connected to it, and hence number of RTUs required will be minimum as number of DGs connected to the feeder. Moreover, the proposed methodology was proven to be working better up to certain level of maximum power output of each DG in the feeder by maintaining the voltage profile within the acceptable range.

## References

- [1] G. Pepermans, J. Driesen, D. Haeseldonckx, R. Belmans, W. Dhaeseleer, "Distributed generation: definition, benefits and issues," *Energy Policy* volume 33, issue 6, pp. 787-798, 2005.
- [2] R.A. Ufa, Y.Y. Malkova, V.E. Rudnik, M.V. Andreev, V.A. Borisov, "A review on distributed generation impacts on electric power system," *International Journal of Hydrogen Energy*, volume 47, issue 47, pp. 20347-20361, 2022.
- [3] W El-Khattam, M.M.A Salama, "Distributed generation technologies, definitions and benefits," *Electric Power Systems Research*, volume 71, issue 2, pp.119-128, 2004.
- [4] T. Ackermann and V. Knyazkin, "Interaction between distributed generation and the distribution network: operation aspects," *IEEE/PES Transmission and Distribution Conference and Exhibition*, volume 2, pp. 1357-1362.
- [5] C. L. Masters, "Voltage rise: the big issue when connecting embedded generation to long 11 kV overhead lines," *Power Engineering Journal*, volume 16, issue 1, pp. 5-12, 2002.
- [6] K. A. Makinde and G. Lacey, "Over-voltage Problem in Distribution Network with DG: A Review of Mitigation Techniques," 56<sup>th</sup> international universities power engineering conference (UPEC), pp. 1-6, 2021.
- [7] N. Alqahtani, S. Ganesan, M. Zohdy and R. Olawoyin, "Overvoltage Mitigation in Distributed Networks Connected to DG Systems," international conference on computing and information technology (ICIT-1441), pp. 1-6, 2020.
- [8] D. T. Chessmore, W. J. Lee, W. E. Muston, T. Anthony, F. Daniel, and L. Kohrmann, "Voltage profile estimation and control of a distribution feeder," *IEEE/IAS Industrial and Commercial Power Systems Technical Conference*, pp. 1-7, 2008.
- [9] Mohamed Elkhatab, "Novel Decentralized Operation Schemes for Smart Distribution Systems," PhD thesis, University of Waterloo, Ontario, Canada, 2012.
- [10] Qiang Fu, Adel Nasiri, Ashishkumar Solanki, Abedalsalam Bani-Ahmed, Luke Weber, and Vijay Bhavaraju, "Microgrids: Architectures, Controls, Protection, and Demonstration," *Electric Power Components and Systems*, 43, (12), pp. 1453-1465, 2015.
- [11] Mohamed E. El-hawary, "The Smart Grid State of the art and Future Trends," *Electric Power Components and Systems*, 42, (3-4), pp. 239-250, 2014.
- [12] Caishan Guo, Fengji Luo, Zexiang Cai, Zhao Yang Dong, "Integrated energy systems of data centers and smart grids: State-of-the-art and future opportunities," *Applied Energy*, volume 301, 2021.
- [13] Junhui Zhao, Caisheng Wang, Bo Zhao, Feng Lin, Quan Zhou & Yang Wang, "A Review of Active Management for Distribution Networks: Current Status and Future Development Trends," *Electric Power Components and Systems*, 42, (3-4), pp. 280-293, 2014.
- [14] J. R. Aguero, "Applications of smart grid technologies on power distribution systems," *IEEE PES Innovative Smart Grid Technologies (ISGT)*, pp. 1-1, 2012.
- [15] N. Rugthaicharoencheep and M. Boonthienthong, "Smart grid for energy management on distribution system with distributed generation," *IEEE International Conference on Cyber Technology in Automation, Control, and Intelligent Systems (CYBER)*, pp. 165-169, 2012.
- [16] M. E. Elkhatab, R. El-Shatshat and M. M. A. Salama, "Novel Coordinated Voltage Control for Smart Distribution Networks With DG," *IEEE Transactions on Smart Grid*, vol. 2, no. 4, pp. 598-605, 2011.
- [17] Yu-Chung Tsao, Vo-Van Thanh, "Integrated voltage control and maintenance insurance planning for distribution networks considering uncertainties," *Electric Power Systems Research*, volume 201, 2021.
- [18] Raghavendra P & Gaonkar, D.N, "Online voltage estimation and control for smart distribution networks," *Journal of Modern Power Systems and Clean Energy*, vol. 4, no. 1, pp. 40-46, 2016.
- [19] S. Jadid, O. Homae, A. Zakariazadeh, "Voltage Control Approach in Smart Distribution Network with Renewable Distributed Generation," *Journal of Iranian Association of Electrical and Electronics Engineers*, 10, (2), pp. 11-22, 2013.
- [20] M. A. Mahmud, M. J. Hossain, H. R. Pota and A. B. M. Nasiruzzaman, "Voltage control of distribution networks with distributed generation using reactive power compensation," 37<sup>th</sup> Annual Conference of the IEEE Industrial Electronics Society, pp. 985-990, 2011.
- [21] D. Das, D.P. Kothari, A. Kalam, "Simple and efficient method for load flow solution of radial distribution networks," *International Journal of Electrical Power and Energy Systems*, volume 17, issue 5, pp. 335-346, 1995.
- [22] W. N. S. E. Wan Jusoh, M. A. Mat Hanafiah, M. R. A. Ghani, and S. H. Raman, "Remote terminal unit (RTU) hardware design and implementation efficient in different application," *IEEE 7<sup>th</sup> International Power Engineering and Optimization Conference (PEOCO)*, pp. 570-573, 2013.
- [23] O. Homae, A. Zakariazadeh and S. Jadid, "Online voltage control approach in smart distribution system with renewable distributed generation," *Proc. of 2nd Iranian Conference on Smart Grids*, pp. 1-6, 2012.
- [24] D. Das, H. S. Nagi and D. P. Kothari, "Novel method for solving radial distribution networks," *IEEE Proceedings - Generation, Transmission and Distribution*, 141, (4), pp. 291-298, 1995.
- [25] Oymak, Aysenur, and Mehmet Rida Tur. "A Short Review on the Optimization Methods Using for Distributed Generation Planning." *International Journal of Smart Grid-ijSmartGrid* 6.3 (2022): 54-64.



- [26] Abouelgheit, Hassan. "Information and Communication Technologies in Modern Electrical Networks: A Brief Review." *International Journal of Smart Grid-ijSmartGrid* 6.2 (2022): 40-47.
- [27] Okedu, Kenneth, Ahmed Al-Abri, and Waleed Al Khalil, "Electricity Sector of Oman and Prospects of Advanced Metering Infrastructures." *International Journal of Smart Grid-ijSmartGrid* 6.1 (2022): 1-12.
- [28] Kakeu, VJ Foba, Alexandre Teplaira Boum, and C. F. Mbey, "Optimal reliability of a smart grid." *International Journal of Smart Grid* 5.2 (2021).
- [29] Gilbert, Gilbert M., Naiman Shililiandumi, and Honest Kimaro. "Evolutionary Approaches to Fog Node Placement in LV Distribution Networks." *International Journal of Smart Grid-ijSmartGrid* 5.1 (2021): 1-14.
- [30] SOUHE, Felix YEM, et al. "Roadmap for smart metering deployment in Cameroon." *International Journal of Smart Grid-ijSmartGrid* 5.1 (2021): 37-44.