

Building Performance Modelling for the First House in Newfoundland Built on PHIUS+2015 Standards and Design of Renewable Energy System

Sabir Manzoor*, M. Tariq Iqbal*, David Goodyear**

*Department of Electrical and Computer Engineering, Faculty of Engineering and Applied Sciences, Memorial University of Newfoundland, St. John's, Canada A1B 3X5

**Building Consultant, PHIUS+2015 Builder, Flatrock, A1K 1C9

(sabirm@mun.ca, tariq@mun.ca, dgoodyear@gmail.com)

Minor corrections / rephrasing, New additions,

Received: 14.07.2020 Accepted: 16.08.2020

Abstract- This paper presents the building performance of a house in Newfoundland, Canada. This house is built under the guidelines of the Passive House Institute United States (PHIUS+2015) standards. This is an important step towards sustainable living in Newfoundland and Canada in general. Detailed energy consumption modelling of the house has been performed along with the steps involved in the simulation process of Passive House planning and renewable energy system sizing. A significant part of the study presents the majority of the construction details of the house and the components involved. In this study, we present actual energy consumption data acquired from the house and the simulation performed in both pre-construction and post-construction phases. Additionally, steps followed during the planning and construction phase have been discussed in detail, and both static and dynamic energy modelling has been compared. Moreover, a cost comparison has been performed to calculate all the additional costs spent on the resources to build the house according to the Passive House (PHIUS+2015) standards; the analysis indicated a cost of 12% extra when compared with the house built under local regulations. Finally, a renewable energy system is proposed for the house to meet the electricity needs of the house.

Keywords Sustainable living; Renewable Energy modelling; Dynamic building simulation; Passive House; EnergyPlus.

1. Introduction

In recent years energy consumption has been increasing, and also it is becoming significantly challenging to devise ways to make efficient use of resources that we have. The principles of Passive House standards provide options to make efficient use of energy, promoting a more sustainable lifestyle. Residential building construction is expected to increase in the future significantly, therefore, building energy conservation has become of utmost importance after the declaration of climate emergency [1]. In a cold climate, a substantial part of electrical energy is spent on heating loads in the residential buildings. Passive House standards have a set of performance metrics that provides planners with goals to meet certain energy requirements for the buildings with considerably low heating and cooling load while maintain a comfortable living environment. While Passive House guidelines are available to help through the construction process [2-5], many things can be done during the planning phase to improve the construction, design and material selection process. These can overall lead to a reduction in the cost and energy expenditures [5] and monthly energy consumption modelling

[6]. This study presents a detailed analysis of a recently constructed house built on PHIUS+2015 standards, which is claimed to be the First Passive House in Newfoundland. Total energy demand data for two years has been collected, and it was analyzed and compared with both static and dynamic simulation tools. Additionally, a detailed study has been completed for a renewable energy system after a complete load analysis of the house.

The primary purpose of this study is to compare total energy demand data of the house with the computer-simulated results and propose a renewable energy system to meet the energy demand. The first section presents a detailed site analysis. Afterwards, section two focuses on building envelope descriptions and different considerations of Passive House planning and simulation because the simulation is the first step in the construction of a Passive House. The simulation approach and validation of the model have been performed with the data logged from the Passive House and by sensitivity analysis using the EnergyPlus simulation engine. Results from WUFI simulation software has also compared with the actual

data in section four. Finally, detailed comparison and cost-benefit analysis show there is a payback period of less than ten years.

1.1 Passive House site analysis

The Passive House Standards were developed in 1990 for the first time, to achieve a residential model that uses substantially less energy than a typical house [7][8]. PHIUS+2015 standards have been introduced in 2015, which were actually built on top of German Passive House standards [8]. PHIUS+2015 guidelines are said to have more personalized requirements tailored to climate and geolocation of the house rather than just having one guideline for every house. PHIUS+2015 designs constraints; when converted into system international (SI) units include but not limited to [4]:

- Heating demand should be less than $43.155\text{W/m}^2\cdot\text{K}$ and $95.39\text{kW/m}^2\cdot\text{year}$
- Cooling demand $7.38\text{--}53.94\text{W/m}^2\cdot\text{K}$ and $5.67\text{--}132.87\text{kW/m}^2\cdot\text{year}$.
- Airtightness should be less or equal to 0.05cfm/sf .
- Source Energy demand $6200\text{kWh/person}\cdot\text{year}$.

Also, the idea for Net-Zero Energy House has also been considered as one of the key solutions to improve upon the concept of Passive House [10]. To create an in-depth understanding of the working principle of the Passive House model and retrofit its design to net-zero energy building, a recently built Passive House in Newfoundland has been selected for the case study, which is shown in Figure 1. This house is located in a cold and humid environment of Newfoundland in Zone 6. According to the ASHRAE standard [11], and the house built on the guidelines of PHIUS+2015. The red colour envelope is the main living area of the Passive House, and the gray colour envelop is the garage consist of a smaller portion of the house, as shown in Figure 1. All fenestrations in the envelope have been selected according to the recommendation to the Passive House consultant, with most windows facing south to gain as much sunlight possible for heating.

Zone 6 in Newfoundland is a cold and humid climate which experience cold winter followed by a warm and humid summer with yearly snowfall can reach up to 250cm. One most important thing to consider is a high amount of wind experienced throughout the year, with an average wind speed of 6.6 m/s [12] which shows good signs for wind energy production. However, to implement an alternative energy solution, it is better to understand the demographics of the selected site. This section is going to discuss in detail, the weather data and possibilities of the other renewable energy resources available for the house. Renewable energy sources for the selected site can be biomass, geothermal, micro-hydroelectric, tidal, wind, solar thermal and solar photovoltaic. Figure 2 shows the satellite view of the house, which is surrounded by other houses, potentially limiting the option of using a wind turbine due to safety reasons because of the moving parts involved. A detailed study for a similar site, which is also the location in the vicinity of other residential houses, shows that only wind and solar resources

can be utilized for the site [12]. Although the same study suggested that the micro-hydro project could have also be implemented if the site would have been in a remote area and need to have access to a potential hydro source. So, one of the best and practical sources to be used at the micro-level is solar photovoltaic because it is easy to install, has the flexibility of designing and cheaper than other sources and flexibility of extension [13]. Moreover, given the current site analysis, it is also possible to have a grid-connected renewable energy generation system, which in our case, gives the ability to feed extra generated electricity to the grid.



Fig. 1. First house built on PHIUS+2015 standards in Newfoundland.



Fig. 2. Satellite location of the Passive House under study.

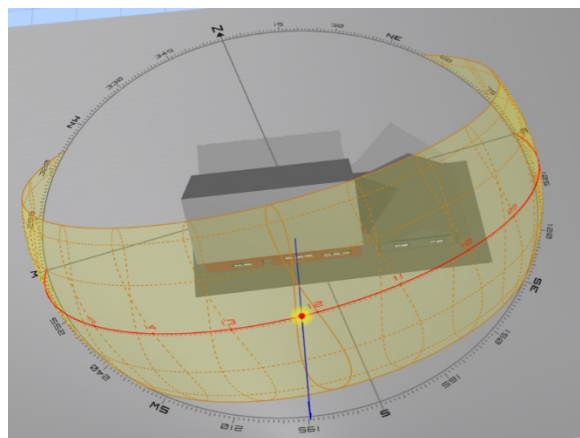

Fig. 3. Top view of the model of the house with the solar chart.

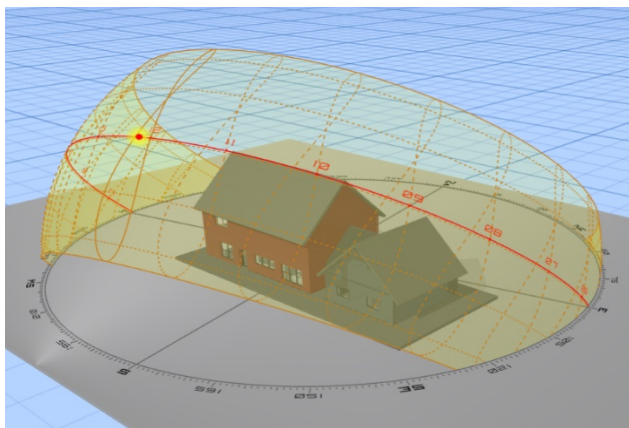

Fig. 4. 3D model of the house with the solar chart.

Figure 3 represents the top view of the house. It can be seen that the house has a roof facing south at an angle of 40 degrees, which gets maximum exposure from the sun. Also, Figure 4 represents the side view of the 3D house designed in SketchUp 3D initially and solar chart generated with Andrewmarsh's online web-based tool [14]. The area of the house selected for solar panel installation is 50 m². Initially, Homer Pro software was used for the sizing and optimization of the PV systems for the house, and finally, results were verified with PVsyst software. During summer, solar radiation reaches up to a fairly good amount of 5kWh/m².day and, irradiance gets lower in the winter, as represented in Figure 5. It can also be seen that the clearness index remains relatively constant throughout the year, with an average value of around 0.45. This data was obtained from a monthly average of 22 years under NASA surface meteorology and solar energy database [15]. Weather data has been downloaded from NASA solar energy database and used in Homer pro optimization [15].

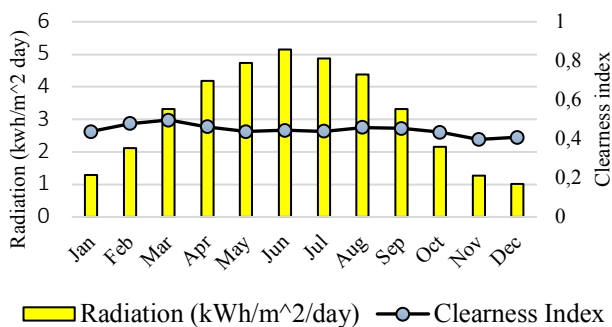

Fig. 5. Solar energy potential for FlatRock Newfoundland.

1.2 Weather condition

For the sake of dynamic simulation, EnergyPlus provides a lot of resources online from its website, and these resources are managed by National Renewable Energy Laboratory. For the first step, climate zone and accurate weather data input is a significant step for the simulation process. So, weather data from the EnergyPlus website has been downloaded. Figure 6 shows the heating degree day data of Canada, according to ASHRAE guideline, and the site with red marker has shown which comes under zone six [11]. The site has a lot of variation

in temperature throughout the year, and the ASHRAE climate zone ranges from 2222-2777 heating degree day (HDD) when data from Figure 6 is converted from Fahrenheit HDD to Celsius HDD. Especially, consideration of outside temperature, humidity and sunlight hour is critical while planning for the house. Figure 7 represents the temperature graph for the site, and it shows a significant variation in temperature from winter to summer, where the temperature goes below zero and gets extremely cold. A similar study [16-18] indicates how important it is to keep all variables like moisture, fluctuating temperature, snow and gust into account while planning the house. Because of the humid nature of the climate, dehumidification is also required during certain times in the year to maintain an indoor comfortable living environment. Those times are mainly summers and shoulder seasons. All these variables can be more effectively stimulated with dynamic simulation tools where the properties of each device installed can be selected along with sudden changes of climate variables to achieve more accurate results.

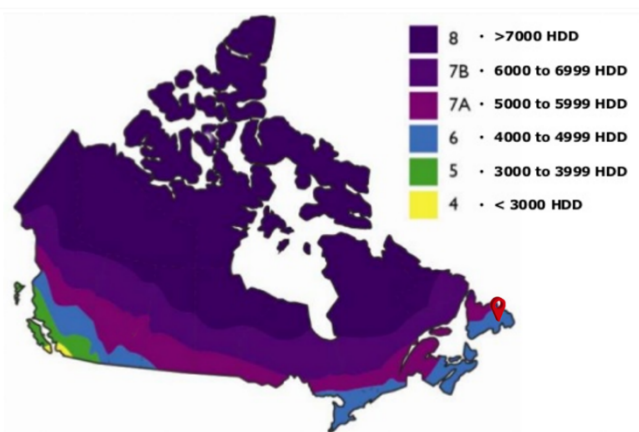

Fig. 6. ASHRAE climate zone distribution with respect to heating degree day (HDD) for Canada [11].

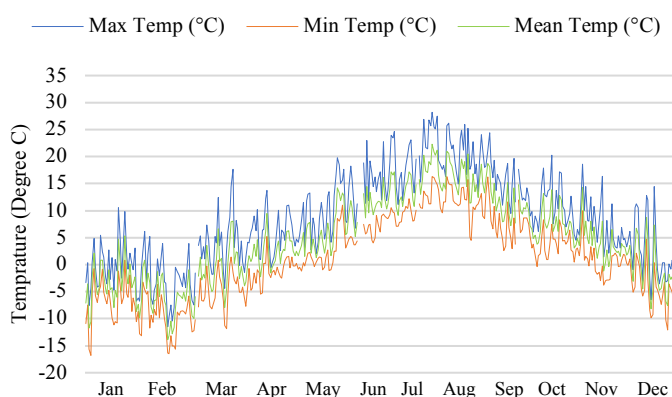

Fig. 7. Temperature graph for the site of the year 2019 (NASA).

2. Building envelop description

The house design was completed after several rounds of renderings and plans with the input of the homeowner and the consultant. The final design of the house, as shown in Figure

1, has been constructed to captures traditional Newfoundland vernacular architectural style, locally known as the Saltbox style. This architecture style is simple and can be built to withstand the Newfoundland cold climate with a steeply pitched roof to protect from snow accumulation and wind-driven rain[19]. The ground floor has a common living area, kitchen, dining room and small room for working space, which is also deemed as a fourth bedroom. A detailed floor plan for the first floor can be seen in Figure 8 for visualization. The floor plan of the second floor of the envelope is also shown in Figure 9. It has three bedrooms, and the total area of the second floor is the same as the first-floor build on a similar layout as of the first floor. The house has a total of 185m² area out of which 113m² area has been designed, built and tested according to the PHIUS+2015 standards. The remainder of the house (garage) is less insulated and not built according to the PHIUS+2015 standard, and hence it is left out of the scope of the study.



Fig. 8. Floor plan of the Passive House (first floor).

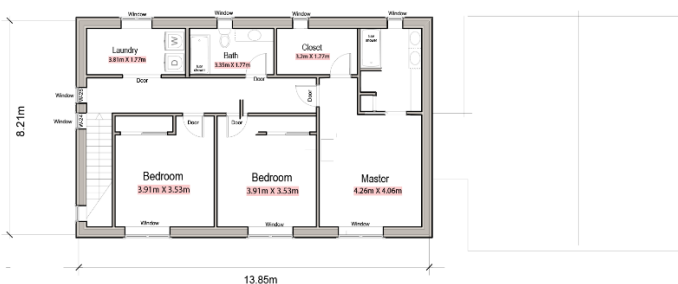

Fig. 9. Floor plan of the Passive House (second floor).

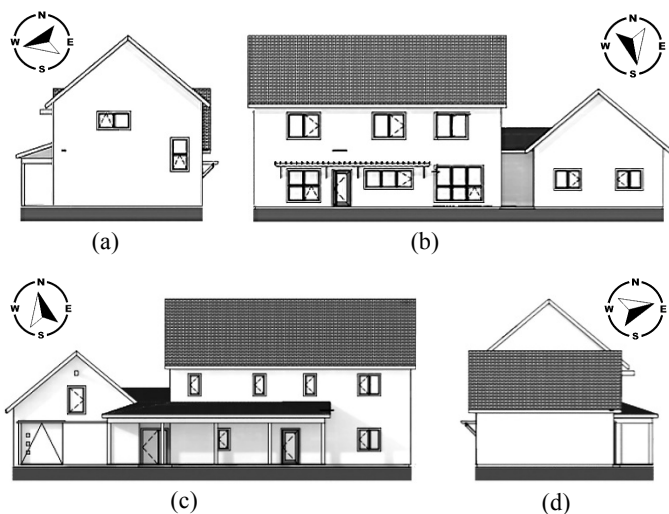

Fig. 10. House elevations from different viewing directions.

Table 1. Window-wall ratio of the model.

	Total	W	N	E	S
Wall Area m ²	271.8	86.4	54.3	75.4	55.7
Glazing area m ²	26.41	5.68	2.78	17.95	0
Window to wall ratio R %	9.71	6.57	5.11	23.8	0

The building site was selected to take advantage of solar radiation during the heating season. Table 1 shows the area of each façade, and the global percentage of the glazing is about 19% of the total opaque façade area. As can be seen in the Table 1, and also in Figure 10(b), the maximum amount of glazing is located in south façade which accounts for 23.8% of the wall. The rest of the façades have 5.1% facing west, 6.57% facing north and zero percent glazing facing east, as shown in Figure 10(a), Figure 10(c) and Figure 10(d), respectively. Triple glazed windows have been deployed to maximize efficiency and reduce heat loss during the winter season. The windows on the south façades were chosen to have higher Solar Heat Gain Coefficient (SHGC) than rest of the building to maximize solar gain. The results of different thermal simulations were tested using EnergyPlus with various configurations of windows and areas.

Furthermore, optimized results can be calculated using simulation analysis [20], with the desired glazing characteristics or specifying known specific heat and conductivity of glazing windows installed and wall insulation specifications. It has been verified that the high-performance windows make a considerable difference in the heat loss or gain for the envelope [21]. In this case study, SHGC of the south-facing windows is 0.58, a total of around 4900kWh/year energy in the form of heat has been lost from the windows and doors, as shown in Figure 11. Moreover, it has been discovered that larger windows lead to higher heat loss and lesser heat gain for the heating season. A detailed study can be explored to analyze the different ratio of the windows with walls; however, overall energy gain and energy loss depends on many other factors, not only the glazing area of the walls [21][22].

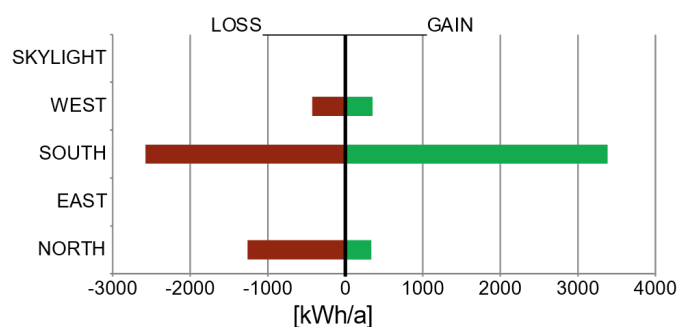

Fig. 11. Energy Loss/Gain from glazing area in kWh/year.

3. Modelling methodology and Boundary conditions:

Building simulation tools are essential for the analysis phase of the build information modelling. Over a period of time, there have been a number of tools developed for energy modelling and building simulation. Each of the software has its unique capability when it comes down to building simulation. There are mainly two types of simulation techniques when it comes down to Passive House; static and dynamic simulation. In a static stimulation, data is assumed to be evenly distributed. Two available tools, designPH/PHPP and WUFI, are most widely used for Passive House package planning [2-4]. On the other hand, dynamic simulation allows robust and advanced techniques where time-dependent changes along with other factors like Heating, Ventilation, and Air Conditioning (HVAC), heat sources, moisture effect etc. are also taken into account. A lot of building energy simulations tools like IDE ICE, EnergyPlus, OpenStudio, eQUEST and DesignBuilder are available and mentioned in the studies which promise high accuracy level for a comprehensive simulation of building design [20-26]. In this study, the EnergyPlus engine and open-studio is used to compare the results with WUFI, which is a Passive House planning tool. Final results are compared with the actual energy consumption data logged from the recently build Passive House.

Inputting exact parameters for building energy simulation needs careful consideration of components involved, including but not limited to division of thermal zones, geometric modelling, software selection that matches the requirement and finally, the selection of meteorological data [27][28]. Geometric modelling represents the first stage of the simulation [29], which consumes typically require exact measurements and knowledge of the site in the process of energy modelling [30]—Moreover, other parameters like material data, shading, glazing, construction attributes, etc. Figure 12 represents the overall methodology adopted for simulation modelling using OpenStudio with the EnergyPlus engine and WUFI planning tool. This methodology represents typical building information and energy modelling with some extra steps involved for more complex high-rise buildings. Starting from the selection of climate data and construction parameters, all the composition data has been selected according to the specifications and later zone connections added for temperature and air flows calculations [31-33].

3.1. Design and specification:

As shown in Figure 12, after 3D modelling and creating a database of material and construction data, the next step is to input the characteristics like shading, causal gains like occupants, lighting, equipment etc. and airflow of the house accurately. Table 2 represents the boundary conditions for the house, which is to be analyzed and Figure 13 represents the 3D model of the house used for simulation. The model uses a concrete slab as the base, and then one top floor plate has been constructed. It is favourable by Passive House standards to have a concrete slab-on-grade to control heat loss from the house to the ground. With added extra insulation in the concrete slab reduces the amount of concrete being used hence reduces overall embodied energy. Additional insulation under the slab can be added in order to decouple the slab for the thermal losses to the ground. The roof of the house has loose fill cellulose insulation that gives the building overall excellent thermal inertia and overall U-value of $0.058\text{W}/\text{m}^2\text{K}$.

The thermal envelope is directly in contact with the external environment; therefore, it acts as the dominant medium through which heat or energy moves between outside and inside of the Passive building. In the enclosure structure, external walls work as the primary constituent and significant area, where all part of the thermal maintenance system contacts. Outer walls account for more than 40% of the whole building energy consumption, so it is important to minimize thermal bridging to the enclosure structure of the envelope [29]. Figure 14 shows the intersection point of the roof and the wall where an extra bit of insulation added the structure to reduce the thermal bridging effect that overall plays an essential role in avoiding energy leakage, mould or moisture accumulation. A detailed Computational Fluid Dynamics (CFD) analysis can be explored with the DesignBuilder tool [33].

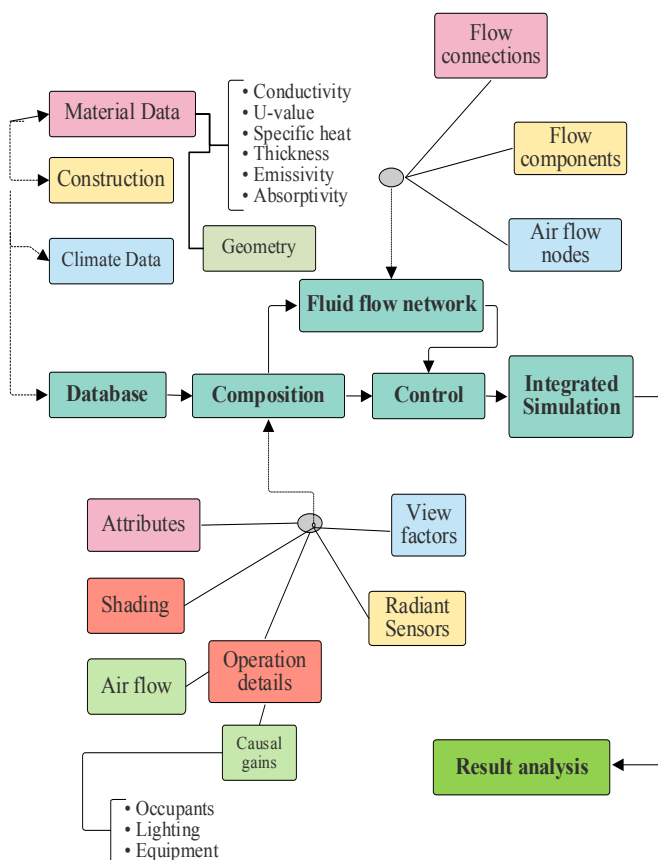

Fig. 12. Typical steps involved in building energy simulation.



Fig. 13. Designed model in sketch-up for visualization.

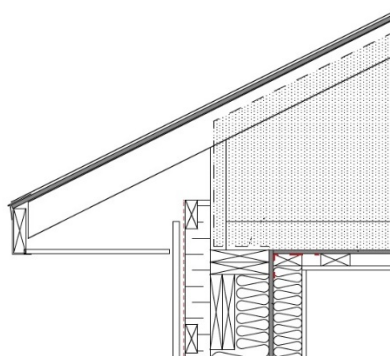
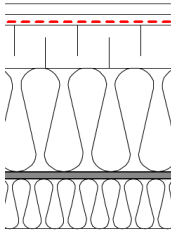
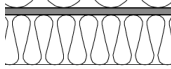
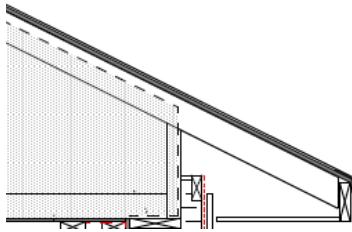

Fig. 14. Representation of roof and walls intersection to avoid the thermal bridging.

Table 2. Design specifications for the simulations.

Boundary Conditions	Building specification
Building types	Optimized energy consumption
Floor area	113m ²
Glazing types	Triple glazed
Infiltration (ACH50)	0.45 /hour
External Walls	<div style="display: flex; align-items: center;"> <div style="margin-right: 10px;">Outer side →</div>  </div>
RSI 10.1 m ² -K/W	
U-Value 0.099 W/m ² -K	<div style="display: flex; align-items: center;"> <div style="margin-right: 10px;">Inner side →</div>  </div>
Source and composition of walls	<ul style="list-style-type: none"> ▪ 1.58cm DRYWALL VAPOR BARRIER PAINT(<1 PERM) ▪ 2X4 STUD WALL W/ TIGHT-FITTING FIBERGLASS BATT INSULATION, 60.96cm O.C. ▪ 1.11 cm OSB WALL SHEATHING AND AIR/VAPOR BARRIER, ALL JOINTS SEALED AND TAPED ▪ 2X8 STRUCTURAL STUD WALL W/ TIGHT-FITTING FIBERGLASS BATT INSULATION, 60.96cm O.C. ▪ WIND BRACING ▪ 7.62cm EPS TYPE 2 CROSS STRAPPED 60cm 26O.C.
Roof	
RSI 17.24 m ² -K/W	
U-Value 0.058 W/m ² -K	
Source and composition of the roof	<ul style="list-style-type: none"> ▪ 1.27cm DRYWALL ▪ 2X4 STRAPPING, 40.64cm O.C. ▪ 1.11cm OSB AIR/VAPOR BARRIER, all joints caulked and taped engineered wood trusses, slopes and overhang ▪ 45.72cm RAISED HEEL ▪ 66cm LOOSE FILL CELLULOSE- SETTLED DEPTH ▪ 5/8" OSB ROOF SHEATHING W/ H-CLIPS
Source and composition of the floor slab and floor plate	<ul style="list-style-type: none"> ▪ 10cm POLISHED CONCRETE SLAB ▪ 15 MIL POLY RADON/VAPOR BARRIER ▪ 25cm TYPE 2 EPS FOAM ▪ 15cm GRAVEL ▪ 3X10cm T&G OSB SUB-FLOOR ▪ 1X4 STRAPPING 40.64cm O.C. ▪ 1.27cm DRYWALL ▪ Painted softwood flooring

The ceiling of the house also occupies a large area and can lead to significant heat loss [34], contributing to increased energy consumption overall. In this house, like any other Passive House [35], the insulation layer of the ceiling structure is specially designed thicker and highly insulated with higher resistance (R-value) than the external wall structure. Moreover, it is crucial to minimize the transport of the moisture in the envelope, so an extra sealing layer and vapour retarder layer can be added to the walls [36], which in this case, the strandboard (OSB) wall sheathing (air barrier and vapour retarder) has been used. So, taking the house boundary conditions as a paradigm, a three dimensional model of the house in SketchUp with spatial zoning and spatial tagging is established by relative design parameters for heat transfer environment and overall envelope, as shown in Table 2 and Figure 13. Having a garage with the design has been ignored while designing the house in WUFI. However, the analysis of different possible structural combinations with varying properties of zoning is possible in the OpenStudio. This software comes with a massive amount of preloaded libraries, and custom libraries have been created, and all reference characteristics for materials have been mentioned in Table 2. Based on the principle of integral variation, the EnergyPlus engine is implemented to simulate the outdoor time-by-case and change of hourly thermal load on the enclosed structure of the envelope. Also, according to the American National Standards Institute / American Society of Heating, Refrigerating and Air-Conditioning Engineers (ANSI/ASHRAE) 90.1 [37] multiple spaces can be represented as one thermal zone with the same heating and air conditioning system applied to have the same orientation of the exterior walls.

3.2. Energy analysis

Table 3 and Table 4 show a comparison of different energy expenditure components involved in the house. As can be seen, that all components of the house and their electricity and non-electric energy demands. Since a Passive House has ultra-low energy consumption [36][38], to serve to this purpose of energy saving, the heat recovery ventilation system (X24ERV model from Venmar) has been adopted, which is fully programable and ventilates according to ASHRAE standards. R-values mentioned in Table 2, are excluding the effect of surface resistance and calculated by the EnergyPlus software after inputting data for each layer in the wall. Since the outer surface resistance depends on the exposure to wind and the site data, the final result of the simulation is calculated by the algorithms of the EnergyPlus engine.

Table 3. Total electricity consumption of the Passive House .

Types	Electricity kWh/year
Direct heating	832
Hot water	2394
Cooling	0
HVAC auxiliary energy	704
Appliances	5770
Current renewable generation	0
Total	9700

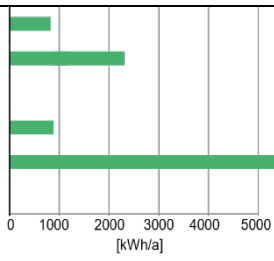

Table 4. A detailed breakdown of the energy demand of the house.

Type	Electric demand kWh/year
Kitchen dishwasher	143
Laundry (Washer only)	137.9
Energy consumed by evaporation	0
Kitchen fridge/freezer combo	452.6
Misc Electric loads	4137.3
Interior Lighting	845.1
Exterior Lighting	54.1
Total	5770

4. Building Performance simulation and results

To calculate energy consumption by each separate boundary condition and each separate room, the EnergyPlus engine is of great help. To understand the energy requirements of each section of the house, Table 5 is shown with heating demand to maintain comfort level and 20 degrees Celsius of indoor temperature with the extreme external condition and dry bulb temperature to be -20 degrees Celsius. Overall, the comparison of the heating and cooling demand for yearly data shows results on par with the static simulation results. As can be seen in Figure 15, Heating1 and Cooling1 are the results produced with the simulation of dynamic modelling while Heating2 and Cooling2 are the pre-construction simulation results with the help of WUFI modelling tool. Passive House Institute United States (PHIUS) has slightly different criteria when it comes to heating/cooling demand and airtightness. As mentioned in the literature review and also on the PHIUS website, criteria are specific to the climate zone where the construction is being done. For PHIUS+ 2015 standard [4] under which target of yearly heating demand has been set to 15kWh/m².

Table 5. Total heating load of the Passive House.

Space	Area (m ²)	Heating Load (W)	Overall (W/m ²)
Office	17	185	10.88
Kitchen	39.2	538	13.7
Living Room	39.3	360	9.16
Bath	9	80	8.88
Laundry	10.4	165.5	15.91
Main Bath	8.2	67	8.2
Master Bedroom	22.9	183.2	7.9
Bedroom 1	18.2	135.2	7.42
Bedroom 2	18.2	135.2	7.42
Master Closet	7.5	59	7.8
Upstairs Hall	9.7	22	2.26

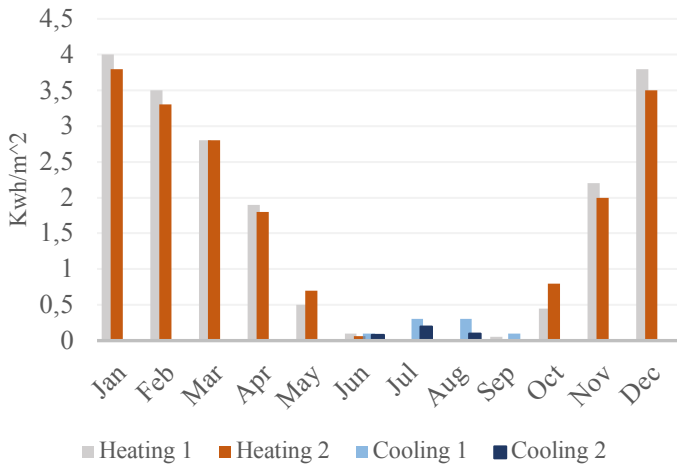

Fig. 15. Comparison of heating and cooling demand simulated with two different software (1 for dynamic modelling and 2 for WUFI modelling).

Although, results for the heating and cooling demand have been on par with the static analysis of the house simulation for the house in the study with the results from dynamic modelling through EnergyPlus. As shown in Figure 16, there has been a slight variation in the results of the electricity consumption of the house from the actual predicted results. EnergyPlus tool gave more realistic and closer results to the real data. There could be other factors affecting the accuracy of the final simulation results as well. One of the most important factors is the hot water consumption, and it is being used as a space heating element that appeared to be ignored in the initial simulation. Moreover, there has been fairly tight fitted fiberglass has been placed in the external walls, which could end up creating a variation in the actual results from the simulation. Also, there has been the involvement of the garage, which has different properties, and individual simulation is quite tricky. Overall results, for ambience temperature and humidity and heating/cooling load, has been on par with the simulation.

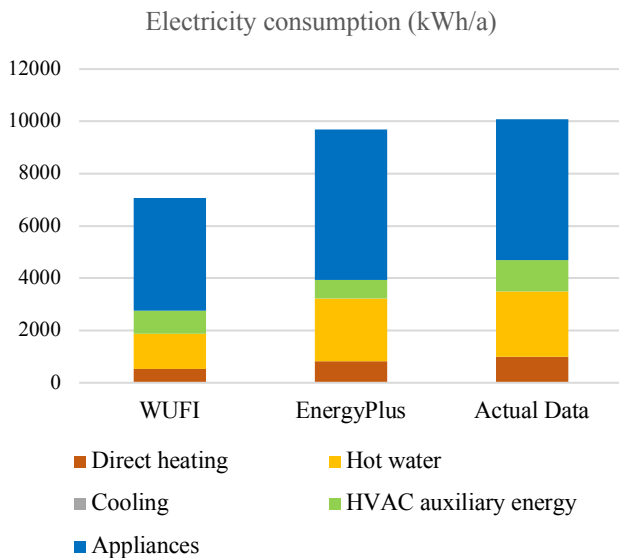

Fig. 16. Average Electricity consumption data comparison of a year.

5. Load analysis and system sizing

This section focuses on system sizing and Photovoltaic system optimization for the house. In Figure 17, an average of two years of energy consumption data of the house shows an average of around 1200kWh/month demand. Figure 5 shows the lowest amount of solar radiation during the winter season when the house has the highest energy consumption. While electricity production is going to increase in summer due to higher solar irradiance shown in Figure 5, load consumption is also going to decrease, as shown in Figure 17. Figure 18 shows that during peak production hours, total electricity consumption is no more than 60% of the peak load, which is mostly during the evenings. An hourly profile throughout the week, which was scaled later to have overall energy consumption in a day, was in the range of ±10%, which is to be noted at 33.66KWh/day. Furthermore, hourly seasonal load data was approximated using reports generated by home’s smart meter and, Figure 19 shows that during peak hours in winter, load reach to maximum rated consumption of 7kW.

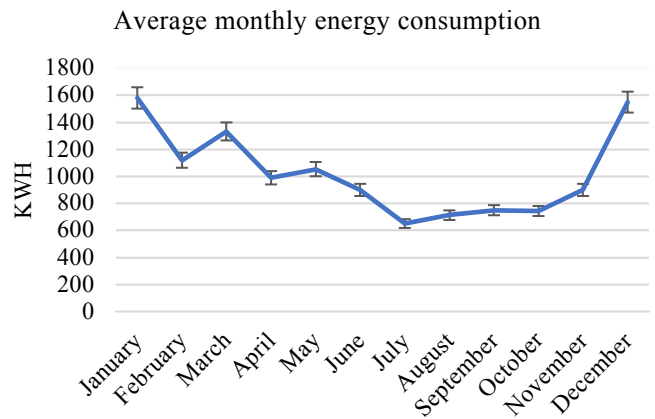

Fig. 17. Average monthly power consumption of the selected site.

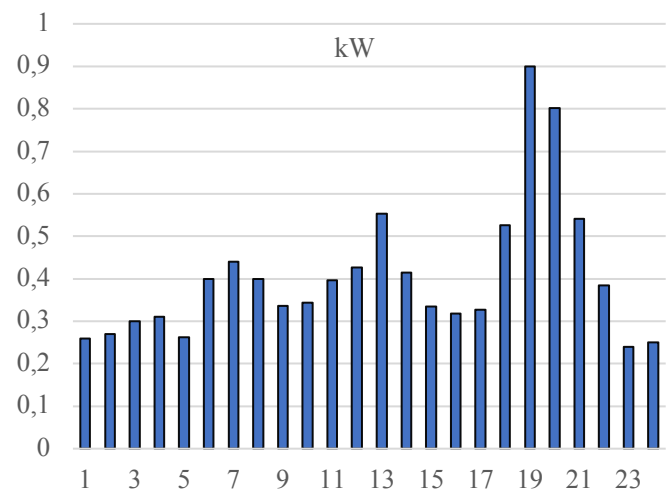

Fig. 18. Average hourly profile of load in a day (scaled to 1kW).

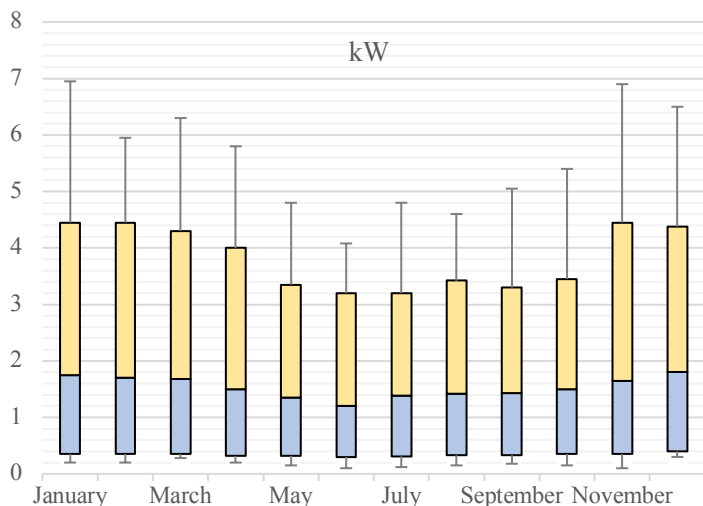

Fig.19. Approximated seasonal load data for the house.

Considering the data given in Figure 5, which shows the average solar potential of 3.15KWh/m²/day. Whereas, the house selected for analysis has an area of 50m². So,

say $\eta_{PV}=15\%$

$$Available\ energy = \frac{3.15\ KWh}{m^2\ day} \times 0.15 \times 50.1m^2 = 32.064 \frac{KWh}{day} \quad (1)$$

Equation (1) shows that the designed PV panels can produce enough electricity to meet the requirement of an average day. This methodology gives a rough estimation ignoring other losses involved in the system. To completely meet the load of the house, solar park has to be created to increase the capacity of the PV generation. An entirely different study needs to be completed on how a maximum area of a building and the characteristics of PV installation. Finally, after simulation of the system in PVSyst, and estimation, the sizing results are further verified using the Homer Pro tool.

5.1. System Specification and Optimization:

For steady-state system analysis and optimized solution, Homer pro software has been used. It allows the user to do sensitivity analysis with all the possible scenarios and gives the user the flexibility to quickly see the impact of on final results with a modified system to get desired optimized results. Now, considering a Grid-connected system structure as shown in Figure 20, integrated blocks selected in the Homer Pro software for simulation and optimization, where sensitivity analysis has been performed, generates over 1000 different combinations were analyzed. Finally, the best possible solution considering capital cost, operating cost, power rating, deterring factor and other variables.

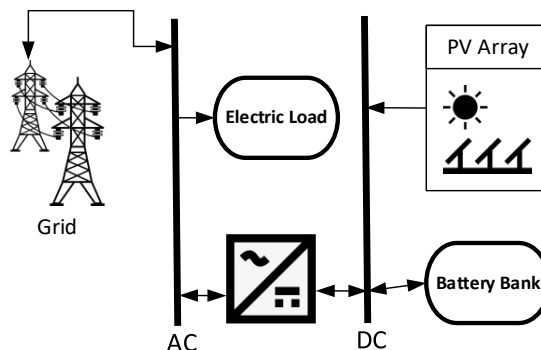

Fig. 20. System dynamics considered for Homer pro optimization.

5.2. System presentation

The selection of a solar panel mostly depends on the quality, price and availability in the local market. This module is 17% efficient with IEC 61215, IEC 61730, TÜV-Rheinland, UL 1703, IEC 61701 and IEC 62716 certificates. For simulation purposes, CanadianSolar (CS6X-325P) has been selected where an estimated one plate costs C\$450, including installation cost. The detailed specification has been shown in Table 6. Figure 21 presents a detailed overview of the final result from optimization. Considering the urban setup, evolving load profile, calculation of shades of nearby buildings or trees and tilt properties of PV panel, other software like PVSyst, Solar Pro and SketchPro helps in optimization to calculate the closest estimate to practical values. Finally, the overall circuit diagram has been presented in Figure 22. The system has been tested and simulated according to the circuit flow and this Figure 22 represents the actual wiring diagram to be installed for the system.

Table 6. System specifications.

Components	PV	Converter	Battery
Rating of each components	325W	8kW	SAGM 12V, 220Ah
Required number	30	1	4
Final rating	9.75kW	8kW	48V, 220Ah
Per Unit installation cost	\$433	\$11,500	\$900
Total Cost	\$12,990	\$11,500	\$3,600

Simulation Results



Fig. 21. Hommer optimized results and parameters.

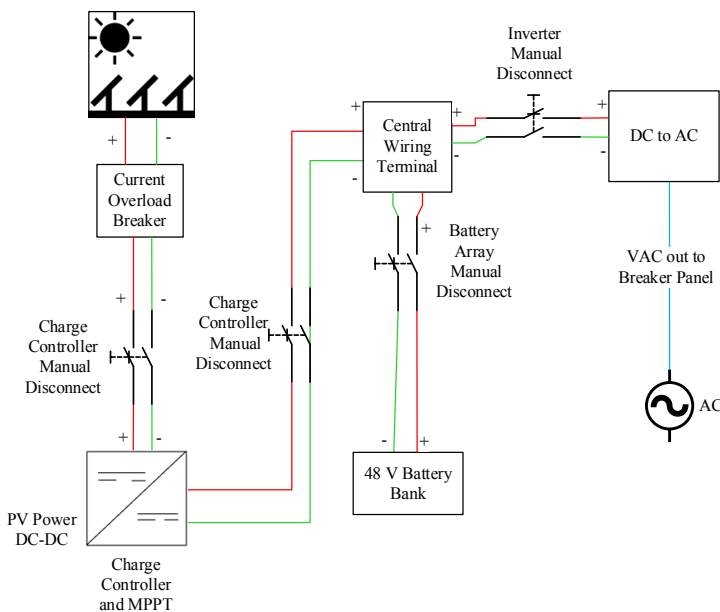

Fig. 22. Proposed system circuit flow.

6. Conclusion and future work:

A detailed analysis of the construction process and energy modelling of the first House in Newfoundland built on PHIUS+2015 guidelines has been performed. It has been discovered that the house does not only focus on cutting down carbon emission by extremely low heating and cooling

demand, but also provides a sustainable solution for the environment of Newfoundland. This style of the house constructed with wood overall has a minimum amount of embodied energy [37][38], overall, less carbon footprint over the period. A hybrid system with wind and solar energy can a

1. Comparing this house with a standard code build house in Newfoundland, there have been some materials like insulation, framing, attic, windows, and tape has been added extra that makes this house different than a standard house. After the cost analysis of the material and labour involved in the construction process, it was determined that additional material costs around \$46,500, which is 12% of the total cost of the house, including labour. So, it has been concluded that comparing the amount of energy saved for heating, this house will payback in less than 25 years and will contribute towards a sustainable living style.

2. Simulation analysis of the house was done using both static and dynamic simulation. After review of the simulation results for the house and results, it can be concluded that both types of tools provide their own unique capabilities. While dynamic simulation using the EnergyPlus engine requires detailed pre-planning of the house with a lot of parameters pre-defined and well known. Moreover, this type of simulation provides more accurate results, but it takes a considerable amount of time and tedious amount of work for setting up the simulation environment. On the other hand, WUFI provides more easy to follow approach to a small house in retrofitting with Passive House standards.

3. The proposed renewable system for the house understudy is going to add a lot of value in terms of sustainable living and solar resource consumption for a low carbon

footprint. Considering the Net-Metering rules for Newfoundland, this system has the benefit of producing around 64% of electricity on its own. From the Homer Pro optimization tool, it has been seen that the system has a payback period of approximately 22 years, which includes the estimated maintenance cost and estimated quotation of the pricing and installation cost. Overall, despite having fewer solar resources and other limitations, this system is a feasible and essential part of the modern standards of future sustainable models of the house. Furthermore, for future work, effect of humidity and wind speed on production can be studied [39] and, for a similar house at a remote location; a hybrid system [40] with improved wind turbine system [41] and intelligent optimization system [42] can provide more promising alternative energy solutions.

7. References

- [1] W. J. Ripple, C. Wolf, and T. M. Newsome, "World Scientists' Warning of a Climate Emergency", *Bioscience. Mag.*, vol. 2000, no. X, pp. 1–20, 2019.
- [2] IPHA [Online] Available from: <https://passivehouse-international.org/upload/ipha-brochure/> [accessed 01 November 2019]
- [3] Passive House institute [Online] Available from: <https://passiv.de/en/index.php> [accessed 01 November 2019]
- [4] Passive house institute US [Online] Available from: <https://www.phius.org/> [accessed 01 November 2019]
- [5] D. Dan et al., "Passive house design-An efficient solution for residential buildings in Romania", *Energy for Sustainable Development*, vol. 32, pp. 99–109, 2016.
- [6] M. Yesilbudak, O. Sagliyan, and A. Colak, "Monthly electrical energy consumption modeling using ant lion optimizer," 8th Int. Conf. Renew. Energy Res. Appl., pp. 977–981, 2019.
- [7] W. Feist, "Improving energy efficiency by a factor of 10 - the passive house standard", *Energy efficiency global forum and exposition*, Washington D.C. 13 Apr. 2011.
- [8] Passive House Institute, *Criteria for the Passive House, EnerPHit and PHI Low Energy Building Standard*, Passive. House Institute., pp. 1–25, 2016.
- [9] J. Schnieders, W. Feist, L. Rongen, "Passive houses for different climate zones". *Journal of Energy and Buildings*, 2015;105:71–87.
- [10] A. Alajmi, S. Rodríguez, and D. Sailor, "Transforming a passive house a net-zero energy house: a case study in the Pacific Northwest of the U.S.", *Energy Conversion Management*, vol. 172, no. June, pp. 39–49, 2018, doi: 10.1016/j.enconman.2018.06.107.
- [11] J. D. Thevenard, "The Calculation of Climatic Design Conditions in the 2005 ASHRAE Handbook – Fundamentals". *ASHRAE Transactions*. 111 (2005): 457-66.
- [12] M. T. Iqbal, "A feasibility study of a zero energy home in Newfoundland", *Renewable Energy*, vol. 29, no. 2, pp. 277–289, 2004.
- [13] E. Brudler et al., "24 years postgraduate program renewable energy", 2nd International Conference on the Developments in Renewable Energy Technology (ICDRET 2012), 2012, pp. 1–4.
- [14] Andrewmarsh's online web-based tool [Online] Available from: <http://andrewmarsh.com/apps/staging/sunpath3d.html> [accessed 01 March 2020]
- [15] Weather data [Online] Available from: <https://disc.gsfc.nasa.gov/>. [accessed 01 March 2020]
- [16] D. Kolokotsa, M. Santamouris, A. Synnefa, and T. Karlessi, "Passive solar architecture", *Comprehensive Renewable Energy*, vol. 3. pp. 637–665, 2012.
- [17] P. Vladykova, C. Rode, J. Kragh, and M. Kotol, "Low-energy house in arctic climate: Five Years of experience", *Journal of Cold Regions Engineering*, vol. 26, no. 3, pp. 79–100, 2012.
- [18] K. Klingenberg, M. Kernagis, and M. Knezovich, "Zero energy and carbon buildings based on climate-specific passive building standards for North America", *Journal of Building Physics*, vol. 39, no. 6, pp. 503–521, 2015.
- [19] M. James and J. Bill, *Passive House in Different Climates: The Path to Net Zero*. New York and London: Routledge, 2016.
- [20] F. Wang, W.-J. Yang, and W.-F. Sun, "Heat Transfer and Energy Consumption of Passive House in a Severely Cold Area: Simulation Analyses", *Energies*, vol. 13, no. 3, p. 626, Feb. 2020
- [21] M. Picco, R. Lollini, M. Marengo, "Towards energy performance evaluation in early stage building design: A simplification methodology for commercial building models", *Energy Buildings* 2014, 76, 497–505.
- [22] S. Elhadad, B. Baranyai, J. Gyergyák, "The impact of building orientation on energy performance: A case study in new Minia", *Pollack Periodica*, 2018, 13, 31–40.
- [23] S. Hoque, "Building Simulation Tools for Retrofitting Residential Structures", *Energy Engineering*, vol. 109, (3), pp. 53-65,67-72, 2012
- [24] I. Brilakis, B. Becerik-Gerber, S. Lee, "Computing in Civil Engineering", Reston: American Society of Civil Engineers; 2013.
- [25] I. J. Ramaji, J. I. Messner, and E. Mostavi, "IFC-Based BIM-to-BEM Model Transformation", *J. Computing in Civil Eng.*, vol. 34, no. 3, pp. 1–13, 2020, doi: 10.1061/(ASCE)CP.1943-5487.0000880.

- [26] M. Jradi, "Dynamic modeling, simulation and energy performance improvement of NASA Ames Sustainability Base". International Conference on Efficiency, Cost, Optimization, Simulation and Environmental Impact of Energy Systems, 2019.
- [27] M. Mihai, V. Tanasiev, C. Dinca, A. Badea, and R. Vidu, "Passive house analysis in terms of energy performance", *Energy Buildings*, vol. 144, pp. 74–86, 2017, doi: 10.1016/j.enbuild.2017.03.025.
- [28] X. Liang, Y. Wang, Y. Zhang, and J. Jiang, "Analysis and optimization on energy performance of a rural house in northern China using passive retrofiting", *Energy Procedia*, vol. 105, pp. 3023–3030, 2017, doi: 10.1016/j.egypro.2017.03.618.
- [29] A. Figueiredo, J. Kämpf, and R. Vicente, "Passive house optimization for Portugal : Overheating evaluation and energy performance", *Energy Buildings*, vol. 118, pp. 181–196, 2016, doi: 10.1016/j.enbuild.2016.02.034.
- [30] J. Zhao, Y. Wu, X. Shi, X. Jin, X. Zhou, "Impact of Model Simplification at Geometric Modelling Stage on Energy for Office Building". Building Simulation and Optimization Conference, (BSO 2018), Cambridge, UK, 11–12 September 2018; pp. 402–406.
- [31] S. Hoque, "Building Simulation Tools for Retrofitting Residential Structures," *Energy Engineering*, vol. 109, (3), pp. 53-65,67-72, 2012
- [32] I. Brilakis, B. Becerik-Gerber, S. Lee, *Computing in Civil Engineering*, Reston: American Society of Civil Engineers; 2013.
- [33] I. J. Ramaji, J. I. Messner, and E. Mostavi, "IFC-Based BIM-to-BEM Model Transformation", *J. Computing in Civil Eng.*, vol. 34, no. 3, pp. 1–13, 2020, doi: 10.1061/(ASCE)CP.1943-5487.0000880.
- [34] X. Liang, Y. Wang, M. Royapoor, Q. Wu, and T. Roskilly, "Comparison of building performance between Conventional House and Passive House in the UK", *Energy Procedia*, vol. 142, pp. 1823–1828, 2017, doi: 10.1016/j.egypro.2017.12.570.
- [35] S. Piraccini and K. Fabbri, *Building a passive house : the architect's logbook*. Green Energy and Technology, Springer, 2018.
- [36] K. Thunshelle and Å. L. Hauge, "User evaluation of the indoor climate of the first passive house school in Norway," *Energy Efficiency*, vol. 9, no. 5, pp. 965–980, 2016.
- [37] S. J. Hong and J. H. Arehart, "Embodied and Operational Energy Analysis of Passive House – Inspired High-Performance Residential Building Envelopes", *Journal of Architectural Engineering*, vol. 26, no. 2, pp. 1–13, 2020, doi: 10.1061/(ASCE)AE.1943-5568.0000405.
- [38] B. S. Rawat, P. Negi, P. C. Pant, and G. C. Joshi, "Evaluation of energy yield ratio (EYR), energy payback period (EPBP) and GHG-emission mitigation of solar home lighting PV-systems of 37Wp modules in India," *International Journal of Renewable Energy Research*, vol. 8, no. 1, pp. 459–465, 2018.
- [39] F. Ayadi, I. Colak, N. Genc and H. I. Bulbul, "Impacts of Wind Speed and Humidity on the Performance of Photovoltaic Module," 2019 8th International Conference on Renewable Energy Research and Applications (ICRERA), Brasov, Romania, 2019, pp. 229-233, doi: 10.1109/ICRERA47325.2019.8996718.
- [40] U. M. Choi, K. B. Lee and F. Blaabjerg, "Power electronics for renewable energy systems: Wind turbine and photovoltaic systems," 2012 International Conference on Renewable Energy Research and Applications (ICRERA), Nagasaki, 2012, pp. 1-8, doi: 10.1109/ICRERA.2012.6477249.
- [41] S. Ozdemir, U. S. Selamogullari and O. Elma, "Analyzing the effect of inverter efficiency improvement in wind turbine systems," 2014 International Conference on Renewable Energy Research and Application (ICRERA), Milwaukee, WI, 2014, pp. 572-575, doi: 10.1109/ICRERA.2014.7016449.
- [42] K. D. Mercado, J. Jiménez and M. C. G. Quintero, "Hybrid renewable energy system based on intelligent optimization techniques," 2016 IEEE International Conference on Renewable Energy Research and Applications (ICRERA), Birmingham, 2016, pp. 661-666, doi: 10.1109/ICRERA.2016.7884417.