

# PSO Supported Dual Matrix Converter for Doubly fed Induction Generated Driven by Variable Speed Wind Turbine System

Ch. Amarendra\*<sup>‡</sup>, K. Harinadha Reddy\*\*

\*Department of Electrical and Electronics Engineering, Koneru Lakshmaiah Education Foundation, Vaddeswaram, AP, India.

\*\*Department of Electrical and Electronics Engineering, Lakireddy Bali Reddy College of Engineering (Autonomous), Mylavaram, Krishna Dt., 521230, Andhra Pradesh, India.

(amarendra.ch@aec.edu.in, kadapa.hari@gmail.com)

<sup>‡</sup>Department of Electrical and Electronics Engineering, Aditya Engineering College (Autonomous), Surampalem, East Godavari Dt, 533437, Andhra Pradesh, India. +91-7729990303, amarendra.ch@aec.edu.in.

*Received: 09.12.2019 Accepted:02.02.2020*

**Abstract-** The growth of wind energy conversion technology has become one of the most important and promising sources of renewable energy. The evolution of wind farms is very recognized in this new trend. This paper concentrates mainly on the performance of the variable speed wind turbine system using the Doubly Fed Induction Generator (DFIG) controlled by Matrix Converter (MC). The DFIG fed by a MC for the best performance of variable wind energy systems. In this paper the Dual MC Drive system was introduced, one MC is placed to control the DFIG and the other kept to control Induction Motor (IM) load. The classic Direct Torque control (DTC) control technique applied on DFIG for getting fixed output voltage. The simple DTC control implemented for the best performance. The Particle Swarm Optimization (PSO) based switching strategy significantly reduces the harmonic content in the MC. In this study, PSO, Mutated PSO (MPSO) techniques were implemented on MC. The proposed test system was discussed and implemented in both software (Matlab/Simulink) and hardware. The DFIG based variable wind energy system with MC and IM controlled MC were implemented in software. With the hardware prototype of the system with IM controlled MC was tested, for the hardware prototype constant wind supply has been assumed. This proposed PSO based switching control strongly recommend for MC fed DFIG performance.

**Keywords** Matrix Converter (MC), Direct Torque Control (DTC), Particle Swarm Optimization (PSO), Modified PSO, Modified hybrid PSO, Mutation PSO, SMPSO, Doubly Fed Induction Generator, Energy Management, Wind Energy Conversion System.

## 1. Introduction

There is a drastic reduction of conventional energy sources and enhancement of non-conventional energy sources. In the last two decades, considerable efforts are kept to make electricity from renewable sources of energy. The best advantages of using renewable are abundance and lack of harmful emissions. Wind energy is the most abundantly available renewable source of energy in nature. The wind energy can be harnessed by a Wind Energy Conversion System (WECS), consists of a wind turbines, electric generator, a power electric converter and the corresponding control system. In wind turbines, mechanical power of the blades is shifted to the turbine rotor either directly or using a gearbox. The wind turbine can either operate at fixed speed

or variable speed. There are several reasons for using a variable speed wind turbine over fixed speed wind turbines as they causes a mechanical stress reduction, noise, possibility to control active and reactive power and provides maximum power tracking from a wind turbine. The DFIG is considered to be the most common configuration used for large variable speed wind turbine that the connected to an AC power grid [1-2].

The classical DTC is a highly dynamic and high performance control technique for induction machine drives as indicated takahashi [3]. The DTC scheme using switching table has some drawbacks switching frequency varies according to the speed and the hysteresis bands of the torque and flux. A large torque ripple is generated is the low speed range and high control sampling time is required to achieve

good performance. DTC is used to combine to MC to obtain a fully controlled DFIG and improve the performance of classical DTC [4,52-54]. The block diagram of the DFIG based AC- AC, MC represented in Figure 1.

The power electronic converters used for wind energy conversion will exhaust the reactive power that is not easy to control and also they produce the harmonics due to high switching frequency [5]. The filters are required to eliminate the higher order harmonics [6]. MC is an AC-AC converter, converts AC-AC directly with different voltage and current parameters. The fundamental difference between the MC and the AC-DC-AC converter is that MC converts AC power without any intermediate elements like capacitor and inductor (or) energy storage elements [5-7]. Absence of large storage elements, MC is compact in size with long life apart from the above advantages [8-10]. Software adopted control structure lead the matrix converter to an interesting research topic for the last few decades. The MC has a bidirectional power flow capability; it consists of bidirectional power switches. The most useful MC has 3 phase input and 3 phase output, the detailed studies of MC, tremendous research work both in simulation and experimental studies about the topology and control methods have been analysed and published in various literatures along with the development of power semi-conductor switches. In MC for three phases, AC-AC converter consists of 9 bidirectional switches arranged in 3X3 matrix shape. In each switching period, duty ratio of each power semiconductor switch is changed according to the applied control strategy, so as to produce the output voltage and current with required amplitude and frequency [11-12]. The detailed control techniques of MC are represented in Figure 2.

The first details were explained in 1971 and 1976 by Pelly B using the name thyristor phase controlled converter and static power frequency changers respectively [13-14]. In 1980 Venturini et al proposed the name Matrix Converter (MC) as generalized transformer, the proposed MC can increase or decrease the voltage magnitude, frequency, phase and power factor from input and output. In 1989 the same authors proposed an improved method from the previous one to increase the voltage transfer ratio 0.866 from 0.5 [15]. The first method is called Venturini method and the second one is called as an improved Venturini method. In the year 1987, Roy G, et al proposed simple control technique named as scalar control. The switching pulses were calculated directly from measurements of the input phase voltages. This method has the limitation that is the voltage transfer ratio is limited to 0.5 similar to the Venturini method [16-18]. The Space Vector Pulse Width Modulation (SVPWM) technique has the capability to achieve full control of both the input current displacement angle and output voltages [19-21]. The Model Predictive Control (MPC) technique is a software based simple technique for switching and controlling of harmonics by introducing observers, thereby reducing the number of voltage and current sensors [22]. This technique still produces small content of harmonics [23]. The soft computing algorithm based techniques still reduces the harmonics of MC [41]. Apart from the above mentioned major contributions, so many advanced modulation strategies

PSO based MC [24] fuzzy logic controller [25, 42] Neuro fuzzy [26] Genetic Algorithm (GA) [27] Hybrid PSO [28] crazy PSO [29] were analysed for minimizing the objective function.

The problem of harmonic can be reduced by the above techniques; another problem with the induction motor drive is torque control. The different methods were explained in the literature. The closed loop adaptive speed observer introduced to enhance the dynamic behaviour of MC fed stator flux oriented DTC induction motor Drive [30]. DTC method for sensor less IM fed MC drive was proposed with less torque ripple and input power factor control. The combination of advantages of MC with DTC strategy using SVM was illustrated. The over modulated strategy proposed to overcome the degradation of dynamic torque response compared to the basic DTC method [31]. DTC for the IM fed indirect matrix Converter (IMC) was presented in [32]. This IMC for input current is applied to the rectifier bridge, while the output voltage is applied to the inverter bridge. The control process can be separated into two modulation process (rectifier stage modulation + inverter stage modulation). The two-stage MC (TSMC) exclusively for bi-directional power flow, and high quality input/output waveforms. The novel direct torque control method for induction motor drive system fed by TSMC, control of AC/DC separately proposed in [33]. The New control scheme based on hybrid particle swarm Optimization, The controller uses the information provided by the torque and stator flux errors to modify the standard DTC voltage vector selection process [34]. A method presented for current control of an IM fed by MC effectively controls the output current from the MC to the machine and the reactive input current to the system [35]. In [36] presents a fuzzy logic controller for a direct torque control of MC fed IM. In [39] presents a new control technique for direct torque control of three-phase IM fed by IMC using fuzzy logic technique. The simulation results of different controllers are compared to get the effective performance of the MC. The motivation of behind this paper is that the advantages of DFIG with MC perfectly suitable for the variable speed wind energy conversion process. The best results can be obtained using the interaction of the DFIG with MC. The proposed new modulation algorithm uses the mutated PSO were implemented. The simulation and hardware results were tested on the test system. The proposed control method exhibits the best performance compared to the conversion methods. The proposed controllers operate on the unity power factor control, i.e. input power factor control is possible with the proposed techniques. The simulation outcome exhibits the strength of suggested controllers to reduce harmonics. The prototype hardware results indicate the same results with the software. This paper is organized as follows. The description of the mathematical modeling of MC is presented in section II. The mathematical analysis of a wind turbine and DFIG modeling is discussed in the section-III. The proposed control strategy explained in section IV. The results obtained by simulation of DFIG-MC and IM-MC are presented in section V. In section VI describes the hardware results. Section VII concludes the paper.

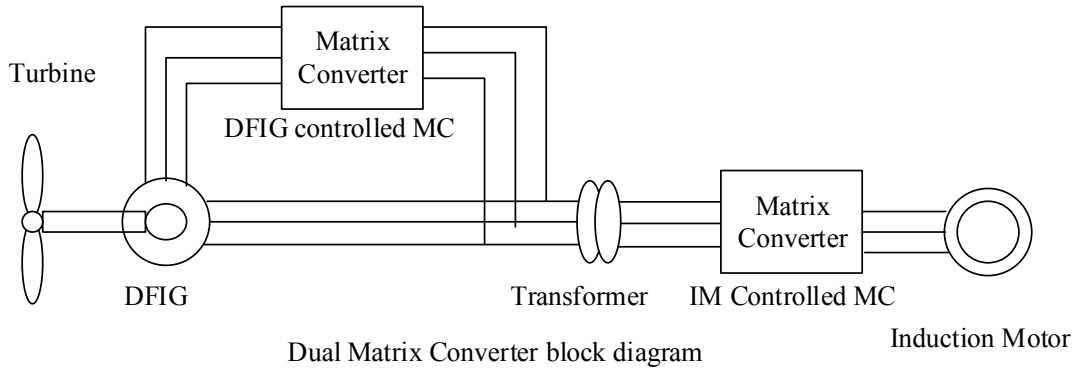

Figure 1 Block diagram of Dual Matrix Converter

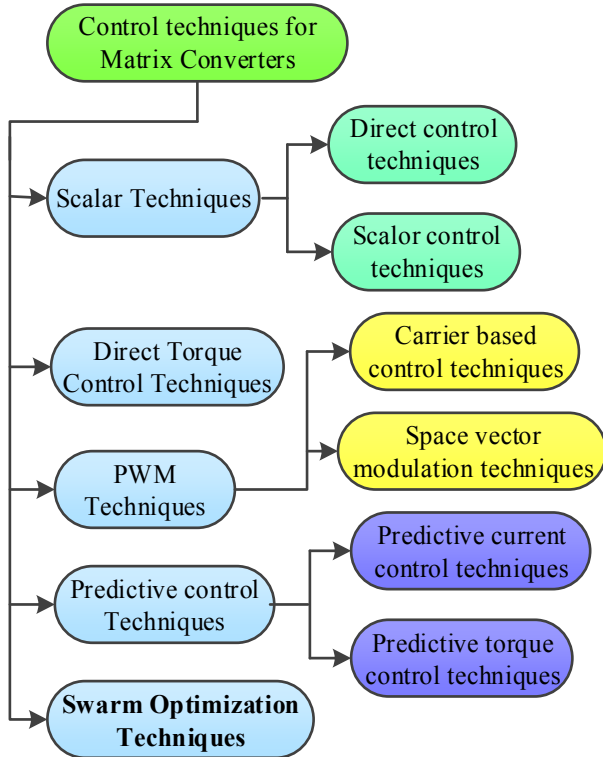

Figure 2 Different types of control techniques for Matrix Converters

2. Mathematical Modeling of Matrix converter

The comprehensive model includes all normal functions of MC i.e. control of the output voltage magnitude, output frequency input displacement power factor [39]. The model is in qdo reference frame for the MC input and output voltage and current fundamental component. Transformation Matrix should satisfy the following requirements i) Restrictions on duty cycle ii) Sinusoidal output voltages with controllable frequency, magnitude iii) Sinusoidal input current with controllable power factor.

The transformation Matrix is two basic solutions (Eq.1-Eq3) that individually satisfy

$$D_1 = \frac{1}{3} \begin{bmatrix} 1+2q \cos(\theta_{s1}) & 1+2q \cos(\theta_{s1}-2\pi/3) \\ 1+2q \cos(\theta_{s1}+2\pi/3) & 1+2q \cos(\theta_{s1}) \\ 1+2q \cos(\theta_{s1}-2\pi/3) & 1+2q \cos(\theta_{s1}+2\pi/3) \end{bmatrix} \quad (1)$$

$$D_2 = \frac{1}{3} \begin{bmatrix} 1+2q \cos(\theta_{s2}) & 1+2q \cos(\theta_{s2}-2\pi/3) \\ 1+2q \cos(\theta_{s2}+2\pi/3) & 1+2q \cos(\theta_{s2}) \\ 1+2q \cos(\theta_{s2}-2\pi/3) & 1+2q \cos(\theta_{s2}+2\pi/3) \end{bmatrix} \quad (2)$$

$$\theta_{s1} = \omega_1 t - (\omega_o t + \alpha_o)$$

$$\theta_{s2} = \omega_1 t - (\omega_o t + \alpha_o)$$

$$\omega_1 t = 2\pi f_1$$

$$\omega_o t = 2\pi f_o$$

$$q = \frac{V_{om}}{V_{im}}$$

$$f_1 = \text{MC input frequency}$$

$$f_o = \text{MC output frequency}$$

$$V_{om} = \text{peak value of output voltage magnitude}$$

$$V_{im} = \text{peak value of input voltage magnitude}$$

$$D = aD_1 + (1-a)D_2 \quad (3)$$

a= constant parameter varying between 0 and 1

Output voltage and input current of MC (Eq.4-Eq.5)

$$\overline{V}_{abc} = V_{im} \begin{bmatrix} \cos(\omega_i t) \\ \cos(\omega_i t - 2\pi/3) \\ \cos(\omega_i t + 2\pi/3) \end{bmatrix} \quad (4)$$

$$\overline{V}_{ABC} = S \overline{V}_{abc} = (a s_1 + (1-a) s_2) \overline{V}_{abc} = q V_{im} \begin{bmatrix} \cos(\omega_o t + \alpha_o) \\ \cos(\omega_o t + \alpha_o - 2\pi/3) \\ \cos(\omega_o t + \alpha_o + 2\pi/3) \end{bmatrix} \quad (5)$$

Output currents (Eq.6-Eq.14)

$$\overline{i}_{ABC} = I_{om} \begin{bmatrix} \cos(\omega_o t + \alpha_o + \phi_o) \\ \cos(\omega_o t + \alpha_o + \phi_o - 2\pi/3) \\ \cos(\omega_o t + \alpha_o + \phi_o + 2\pi/3) \end{bmatrix} \quad (6)$$

$$\overline{i}_{abc} = D^T \overline{i}_{ABC} = q I_{om} \left\{ \begin{bmatrix} \cos(\omega_i t + \phi_o) \\ a \cos(\omega_i t + \phi_o - 2\pi/3) \\ \cos(\omega_i t + \phi_o + 2\pi/3) \end{bmatrix} + (1-a) \begin{bmatrix} \cos(\omega_i t - \phi_o) \\ \cos(\omega_i t - \phi_o - 2\pi/3) \\ \cos(\omega_i t - \phi_o + 2\pi/3) \end{bmatrix} \right\} \quad (7)$$

$$\overline{i}_{abc} = i_{im} \begin{bmatrix} \cos(\omega_i t + \phi_i) \\ \cos(\omega_i t + \phi_i - 2\pi/3) \\ \cos(\omega_i t + \phi_i + 2\pi/3) \end{bmatrix} \quad (8)$$

Where  $\phi_i$  is the input displacement angle

$$q I_{om} \{ a \cos(\omega_i t + \phi_o) + (1-a) \cos(\omega_i t + \phi_o) \} = I_{im} \cos(\omega_i t + \phi_i) \quad (9)$$

$$q I_{om} \{ \cos(\omega_i t) \} \cos(\phi_o) + (1-2a) \sin(\omega_i t) \sin(\phi_o) = I_{im} \{ \cos(\omega_i t) \cos(\phi_i) - \sin(\omega_i t) \sin(\phi_i) \} \quad (10)$$

$$q I_{om} \cos(\phi_o) = I_{im} \cos(\phi_i) \quad (11)$$

$$q i_{om} (1-2a) \sin(\phi_o) = -I_{im} \sin(\phi_i) \quad (12)$$

$$a = \frac{1}{2} \left( 1 + \frac{\tan \phi_i}{\tan \phi_o} \right) \quad (13)$$

$$DPF_{in} = \cos \{ \tan^{-1} [(2a-1) \tan(\cos^{-1} / DPF_{out})] \} \quad (14)$$

Where  $DPF_{in} = \cos(\phi_i)$  and  $DPF_{out} = \cos(\phi_o)$

### 3. Modeling of wind turbine and DFIG

#### a. Wind turbine model:

The algebraic relation between wind speed ( $V_w$ ) and mechanical power extracted ( $P_m$ ) is described by the following relation (Eq.15-Eq.18)

$$P_m = 0.5 \rho A V_w^3 C_p(\lambda, \beta) \quad (15)$$

$$C_p(\lambda, \beta) = 0.5 (116/\lambda_1 - 0.4\beta - 5) e^{(21/\lambda_1)} \quad (16)$$

$$\lambda_1 = (1/(\lambda + 0.08\beta) - 0.035/\beta^3)^{-1} \quad (17)$$

$$\lambda = W_t / V_t \quad (18)$$

The mechanical torque of the turbine is expressed as (Eq.19)

$$T_m = P_m / W_t \quad (19)$$

The power coefficient  $C_p$  of a wind turbine is not constant, but raises with wind speed, rotational speed of the turbine and the pitch angle ( $\beta$ ). In practice a wind turbine generator with good blade,  $C_p$  may reach a value of 0.5.

#### b. Doubly fed Induction generator model

The mathematical dynamic model of DFIG in d-q form can be written as follows (Eq.20-23)

$$\frac{1}{W_b} \frac{d\psi_{ds}}{dt} = R_s i_{ds} + \omega_s \psi_{qs} + V_{ds} \quad (20)$$

$$\frac{1}{W_b} \frac{d\psi_{qs}}{dt} = R_s i_{qs} + \omega_s \psi_{ds} + V_{qs} \quad (21)$$

$$\frac{1}{W_b} \frac{d\psi_{dr}}{dt} = R_r i_{dr} + (\omega_s - \omega_r) \psi_{qr} + V_{dr} \quad (22)$$

$$\frac{1}{W_b} \frac{d\psi_{qr}}{dt} = R_r i_{qr} + (\omega_s - \omega_r) \psi_{dr} + V_{qr} \quad (23)$$

d-q stator and rotor fluxes are described (Eq.24-Eq.27)

$$\psi_{ds} = -(L_{ls} + L_m) i_{ds} - L_m L_{dr} \quad (24)$$

$$\psi_{qs} = -(L_{ls} + L_m) i_{qs} - L_m L_{qr} \quad (25)$$

$$\psi_{dr} = -(L_{lr} + L_m) i_{dr} - L_m L_{ds} \quad (26)$$

$$\psi_{qr} = -(L_{lr} + L_m) i_{qr} - L_m L_{qs} \quad (27)$$

The electrical active and reactive power delivered by the stator (Eq.28-Eq.29)

$$P_s = \frac{3}{2} (V_{ds} i_{ds} + V_{qs} i_{qs}) \quad (28)$$

$$Q_s = \frac{3}{2} (V_{ds} i_{qs} - V_{qs} i_{ds}) \quad (29)$$

The electrical active and reactive power delivered by the rotor circuit is given by (Eq.30-Eq.31)

$$P_r = \frac{3}{2} \frac{P}{2} (V_{dr} i_{dr} + V_{qr} i_{qr}) \quad (30)$$

$$Q_r = \frac{3}{2} \frac{P}{2} (V_{dr} i_{qr} - V_{qr} i_{dr}) \quad (31)$$

The electromagnetic torque based on rotor fluxes and rotor currents can be expressed as (Eq.32)

$$v_i^{t+1} = \omega \cdot v_i^t + C_1 r_1 (P_{best}_i^t - s_i^t) + C_2 r_2 (G_{best}^t - s_i^t) \quad (33)$$

$$S_i^{t+1} = S_i^t + V_i^{t+1} \quad (34)$$

Where  
 $t = 1, 2, 3, \dots, n$  and  $n$  is the size of the swarm

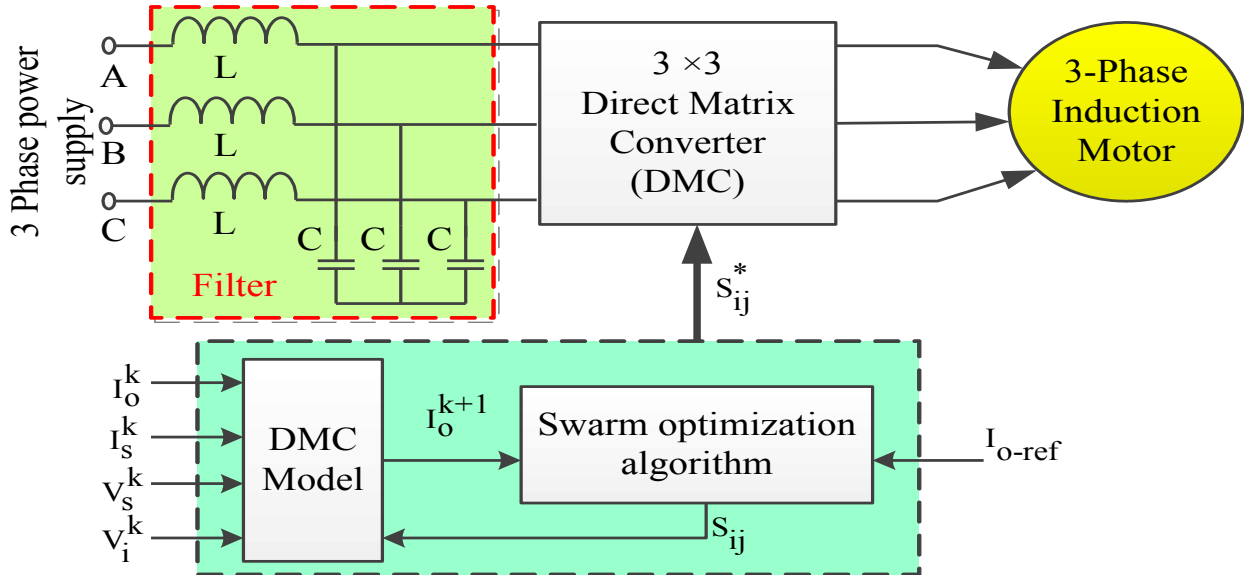

Figure 3 Optimized switching strategy determination with swarm optimization controllers

**4. Proposed control techniques**

The test system considered in this study consist of a three phase 3\*3 MC, which is fed by a three phase voltage source through an input LC filter to drive the induction motor load for getting variable voltage and current. To control the switching states, different types of swarm optimization based control techniques are suggested. The new optimized switching strategy with proposed swarm optimization controllers is represented in Figure 3. The swarm optimization algorithms are based on the food finding behavior of the animals which can optimize the problem literally as per the given rules and procedures.

*4.1 Particle Swarm Optimization technique*

PSO algorithm was first proposed by Kennedy and Eberhart in 1995, based on the food finding behavior of the bird flocks [43-44]. Due to its speed of response, better solutions and shorter programming codes it is separated from the other techniques. The particles which produce the hidden solutions are used in this technique. Each particle rides in the free space with a certain velocity, which can be controlled with previous experiences. The draft situation of the particle of the swarm, with a particle velocity, at iteration is defined as (Eq.33-Eq.34)

$\omega$  = inertia weight factor  
 $C_1, C_2$  = position constants  
 $r_1, r_2$  = random numbers  
 $P_{best}_i$  = the best previous position of the  $i$ th particle  
 $G_{best}$  = best particle among all the particles in the swarm

In the typical PSO algorithm, the inertia weight vector  $\omega$  ranges 0.9 to 0.4 and regulates the previous involvement of the particles. The step wise PSO algorithm is shown below

Step 1: By using state variables, the velocities and search points are randomly generated. The position of a the agent can be served as (35)

Step 2: Velocity of particular fragment can be adjusted by using (Eq.33)

$$S_{ij}^k = \begin{bmatrix} S_{11}^k & S_{12}^k & S_{13}^k \\ S_{21}^k & S_{22}^k & S_{23}^k \\ S_{31}^k & S_{32}^k & S_{33}^k \end{bmatrix} \quad (35)$$

Step 3: A velocity, which moderately gets the situation close to  $P_{best}$  and  $G_{best}$  can be updated by (Eq.34). The adjustment of a searching point by PSO and the behavior of particle in a search space move towards the best position.

Step 4: The fitness function is consummated from the objective function. The objective function is the value obtained in the Simulink model using THD

block available in the library. The fitness function of each particle in the initial position is calculated using mathematical modelling of matrix converter. Based on the switching matrix (Eq.35) The initial best calculated value among Pbest is set as Gbest.

Step 5: The fitness function values are evaluated to update the position of the particles as presented in Figure 4 the fitness function in this paper is the output voltage THD value of the MC.

Step 6: If the terminating criteria are met, the method stops. The stopping criteria are nothing but the net difference between two consecutive iterations is less than 1 or six iterations. The six iterations are chosen because of the selection time for the optimum switching state must be less the sampling time.

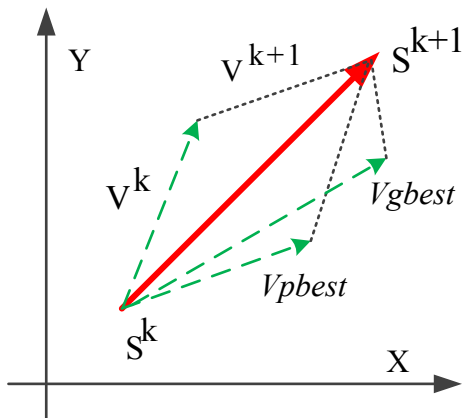

Figure 4 Approach of adjustment of a searching point by PSO

The arithmetic mean is enforced in Pbest, Gbest and velocity renews calculations to utilize the old history of the positions and velocities. The early three iterations of the Pbest values are determined and stored in an array for the next iteration. The arithmetic mean is enforced to the previous iteration and stored Pbest values to get the new Pbest value. Thus the same formula is followed in calculating Gbest and velocity updates [45].

#### 4.2. Modified Particle Swarm optimization

The arithmetic mean is enforced in Pbest, Gbest and velocity renews calculations to utilize the old history of the positions and velocities. The early three iterations of the Pbest values are determined and stored in an array for the next iteration. The arithmetic mean is enforced to the previous iteration and stored Pbest values to get the new Pbest value. Thus the same formula is followed in calculating Gbest and velocity updates [45].

#### 4.3. Modified Hybrid Particle Swarm Optimization

The solution quality was improved rapidly with the use of MPSO technique. The local search methods will get the solution to optimization problem early [46]. By utilizing the effectiveness of both local search technique and PSO

technique, the new optimization technique is developed with more efficiency called MHPSO [47]. Hence MHPSO algorithm operates in two stages.

Stage 1: By the use of MPSO technique, optimal area is obtained early

Stage 2: Direct search technique is employed for getting the optimized result

#### 4.4. Cauchy Mutation PSO (CMPSO)

The mutation PSO techniques are used to eliminate the loss of diversity problems in the PSO [50]. If the searching neighbours are added in each immediate production, the search space is extended. It is used in the CMPSO to get overall best position of each particle. The CMPSO operator is characterized by (Eq.36) to get the optimal result

$$\omega(i) = \frac{\sum_{j=1}^N v[j][i]}{N} \tag{36}$$

#### 4.5. Adaptive Polynomial Mutation PSO (APMPSO)

The current position and velocity will decide the new position in the PSO algorithm [48-49]. The individual Pbest and Gbest will influence the current velocity of the particle. If Gbest changes, the velocity of the particle also changes and the new particle searches the other regions for better values. At the end of each rule the particles are mutated with the equations (Eq.37)

$$S_{ij} = S_{ij} + \sigma * \exp(\tau F(0,1) + \tau F_j(0,1)) \tag{37}$$

#### 4.6. Sobol Mutation PSO (SMPSO)

The SMPSO is familiar with improving the behaviour of the basic PSO algorithm [51]. The recommended SM operator is defined as

$$SM = R_1 + \left( \frac{R_2}{\ln R_1} \right) \tag{38}$$

Where R<sub>1</sub> and R<sub>2</sub> are the accidental numbers in the sobol progression.

The quasi arbitrary number used by the SM dealer permits the best particle to improve consistency and helps in seeking the search space further efficiencies. The suggested method star like the standard PSO algorithm up to the point of examining the position and acceleration of the particles. Then the Sobol mutation is applied to build a disturbance in the population. The comprehensive algorithm containing SMPSO presumed below

- Step 1: Program the seed in the population.
- Step 2: Computerize x[i] with systematically distributed random data.
- Step 3: Calculate the objective function of x[i] as well as designate the cost of fitness [i]
- Step 4: Program Pbest [i] using a replicated value of x[i]
- Step 5: Compute Pbest – fitness [i] having a replicate in regard to fitness [i]

Step 6: Reiterate prior to stopping touchstone is attained for every particle [i]

Step 7: Revise v[i] as well as x[i]

Step 8: Revise Pbest as well as Gbest with the fitness values

Step 9: Sobol mutation

Discover an advanced particle with the use of SM agent (Eq.38-Eq.39)

$$TX=R_1+\left(\frac{R_2}{\ln R_1}\right) \tag{38}$$

$$f(TX) < f(Pbest) \quad Pbest=TX \tag{39}$$

### 5. Simulation Results

Each of the proposed controllers was tested on the matrix converter model expressed in the previous section. In PSO algorithm, the inertia weight  $\omega$  is regarded crucial for PSO convergence. The inertia weight work to control the impact of the earlier history of velocities on the current one. Correspondingly, the parameter  $\omega$ , control the trade-off surrounded by global and the local examination skills of the swarm. An acceptable significance for the inertia weight  $\omega$  generally provides balance between global and local exploration qualifications and subsequently result is a contraction of the number of iterations required to find the optimum result. The maximum weight is fixed to 0.9 and minimum weight is set to 0.4. The existing conditions of C1 and C2 don't seem to be essential for the convergence of PSO. On the other hand, correct sophistication can result in faster convergence and mitigation of local minima. An extensive depiction of the stimulation parameter is the first variation of the PSO. The acceleration factors C1 and C2 equal to 2. The existing conditions of rand1 and rand2 are used to deal with the diversity of the population additionally they are uniformly distributed in the area [0, 1]. Figure 5 shows the fitness values for each technique with iterations. Table 1 represents fitness values of all optimization methods. The Figure 6 to Figure 9 shows the output voltage waveforms and THD analysis with IM as a load for PSO, MHPSO, CMPSO and SMPSO techniques as controllers. The simulation models results the best results of each percentage of THD method after the termination criteria that 9.02, 7.68, 8.21 and 5.02 for the techniques PSO, MHPSO, CMPSO and SMPSO respectively. In Figure 12 the three phase voltages were shown. The three phase output currents were shown in Figure 10. The Figure 11 shows the input voltage and current so that the MC operates on the unity power factor. The DTC control of IM drive was implemented, the Figure 13 represents the Flux space vector trajectory. The output voltage of DFIG controlled MC is represented in Figure 14. The results obtained at the end of each optimization method were cumulatively explained. Different optimization based control methods were analysed on the same load condition. In all the results the input currents of MC are obtained to be sinusoidal. It is also identified that the minor harmonic content in the input current and output voltage still present. According to IEEE 519 the voltage harmonics in power system 69KV should be limited to below 5% THD. When the Obtained results were

compared with the similar work done in the reference [41], there is no much difference between the values obtained and the literate values, but the minor improvement in output voltage harmonic content. Other future of the proposed method is that the simulation time is comparatively less with in the 6 iterations the fitness value reaching its optimum value. The major drawback of the proposed method is that the obtained output voltage harmonic value is more than the standard value. So, this work has the scope study further to reduce the harmonic content below the specific value using advanced metaheuristic optimization algorithms.

### 6. Experimental investigations with SMPSO

The fabricated MC fed IM drive test system model were shown in the figure 16. For proper operation of any power semiconductor switch, gate drive circuit is required. The gate drive circuit and IGBT switching module shown in the Figure 17. In Figure 18 shows the 6 IGBT switches for one leg implementation. Experiments are carried out to verify the validity of the proposed SMPSO with an induction motor drive for the matrix converter. Each and every iteration end the optimal switching states were stored and applied finally to the MC. In this experiment the stator currents are almost sinusoidal and stator voltage with less ripple content. The Matrix Converter hardware model can be designed using microcontroller, but the implementations of 9 switching pulse are difficult with the microcontroller. The delay time and commutation time are in such a way that it should not create the open circuit at output and short circuit at the input, for this specific purpose FPGA sparton-6 is chosen for generation of switching pulses shown in Figure 15. In the MC, there will be overvoltage that should be managed, the source of overvoltage is grid perturbation and fault states in the load. A conventional and standard way is to use a clamp circuit. In normal operation of MC, the diode is off, the clamp circuit has no influence on the MC operation. In hardware model 18 IGBT switches are used, rated 15A, 1200V (FGH15T120SMD), the other hardware parameters are listed in Table II for R-L and induction motor loads. The fabricated model output current waveform of the MC shown in Figure 19. In Figure 20 output voltage waveforms were shown. Input voltage and current waveforms of the fabricated MC fed IM test system were represented in Figure 21.

**Table 1:** Prototype parameters

Name of the Parameter		Value
$V_s$	Source voltage	380V
$f_s$	Source frequency	50 Hz
$I_o$	Load current	10 A <sub>pp</sub>
$f_o$	Load frequency	50Hz
$L_f$	Filter inductance	30mH
$C_f$	Filter capacitance	150uF
$R_f$	Filter resistance	0.5 ohms
$L_o$	Load inductance	15mH
$R_o$	Load resistance	10 ohms
$T_s$	Sampling time	50us

**Table 2:** Simulation of results for different techniques

Method	1st iteration	2nd iteration	3rd iteration	4th iteration	5th iteration	6th iteration
PSO	21.76	19.67	15.15	12.39	10.12	9.02
MPSO	21.76	18.3	14.12	12.01	9.98	8.12
MHPSO	21.76	18.12	13.92	11.12	10.1	7.68
CMPSO	21.76	16.02	14.32	12.22	9.79	8.21
APMPSO	21.76	15.12	14.15	11.59	8.89	7.56
SMPSO	21.76	15.13	12.15	10.89	7.23	5.02

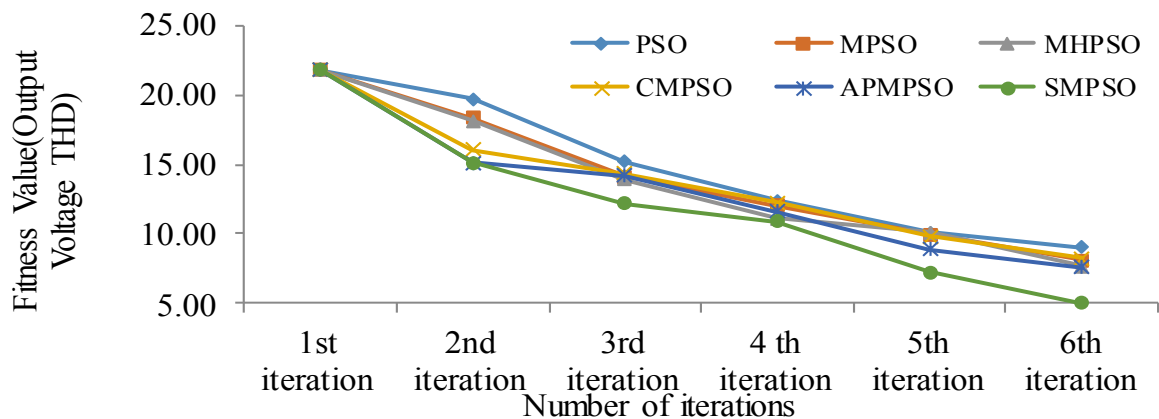

Figure 5 Fitness value of each iteration of different PSO methods

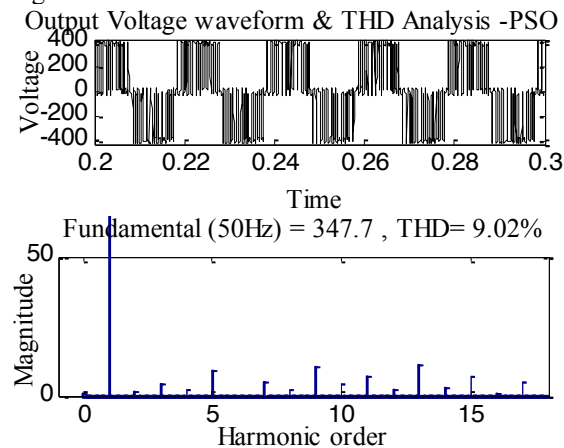

Figure 6 Output load voltage and THD of PSO technique

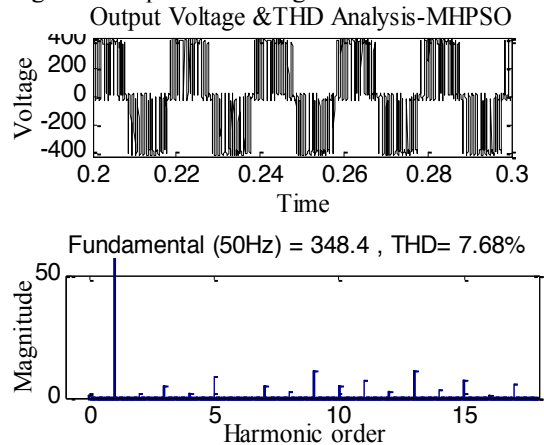

Figure 7 Output Voltage and THD analysis of MPSO technique

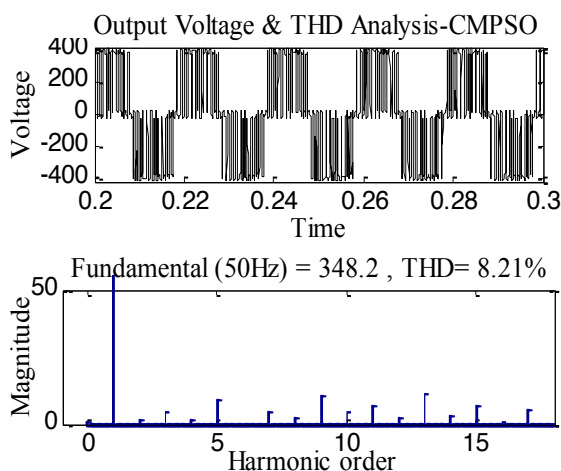

Figure 8 Output load voltage and THD analysis of CMPSO technique

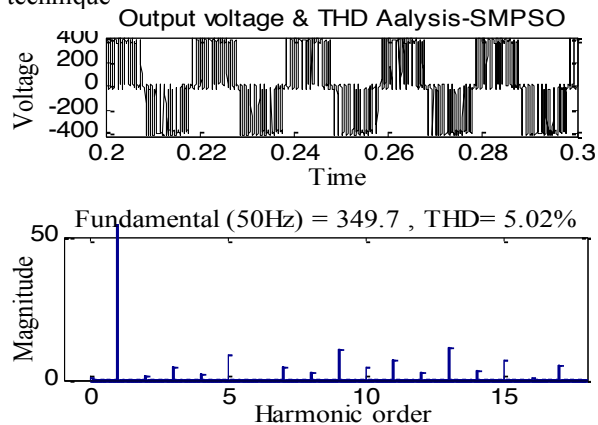

Figure 9 Output Voltage and THD analysis of SMPSO technique



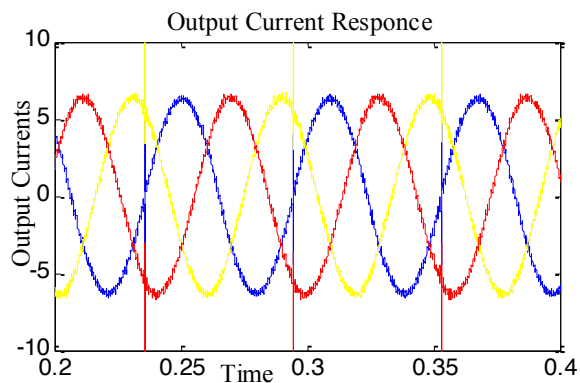

Figure 10 Three phase output Current wave forms of IM Controlled MC

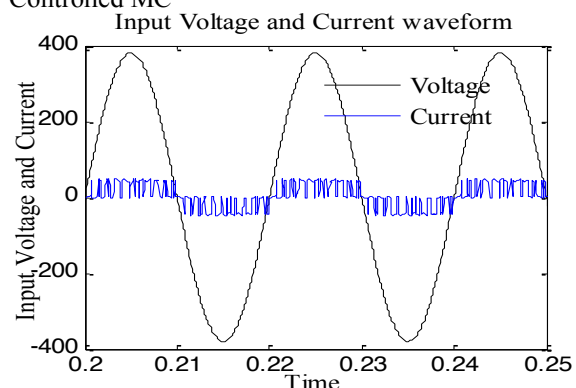

Figure 11 Input current and voltage waveforms of DFIG controlled MC

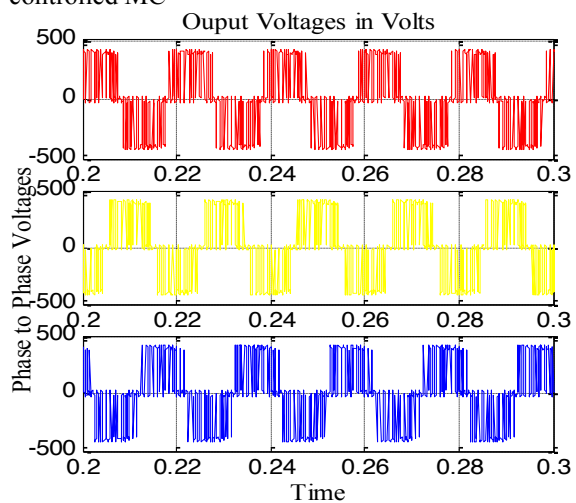

Figure 12 Three phase output load voltages

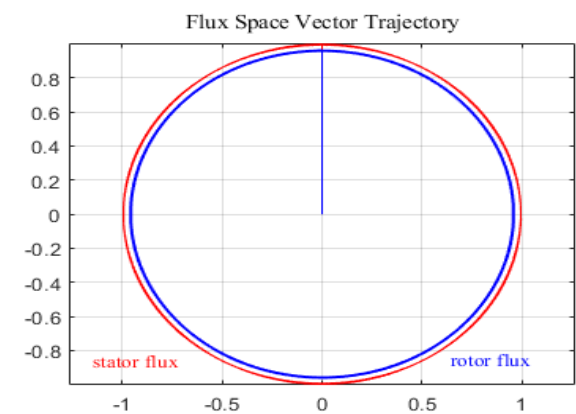

Figure 13 Flux Space Vector Trajectory

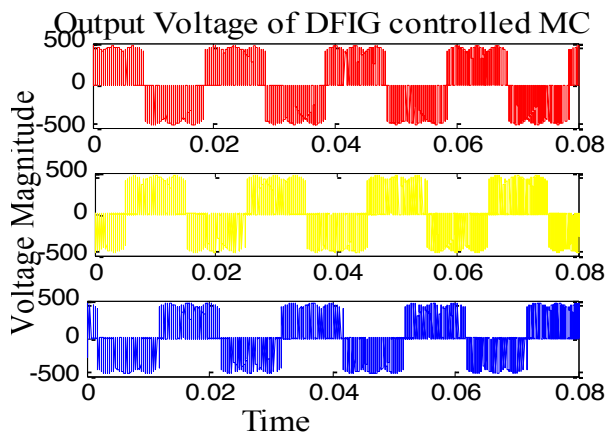

Figure 14 Output voltage waveform of DFIG controlled MC



Figure 15 Control unit of Spartan -6 board

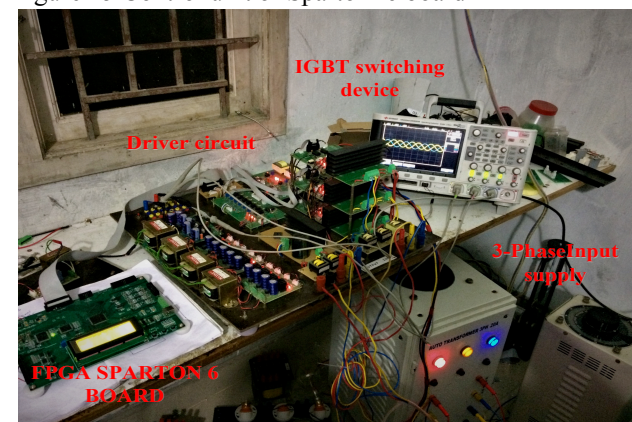

Figure 16 Experimental setup of Dual MC

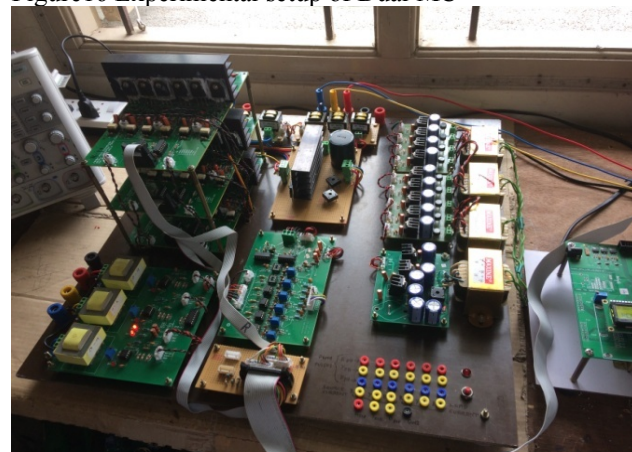

Figure 17 Driver circuit and IGBT switching circuit

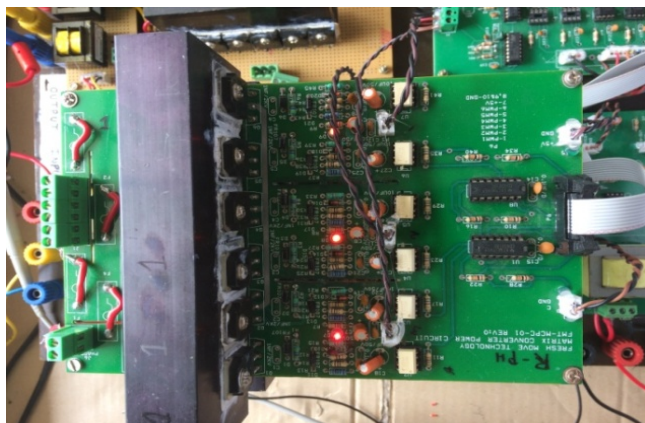

Figure 18 6 IGBT switches for one leg

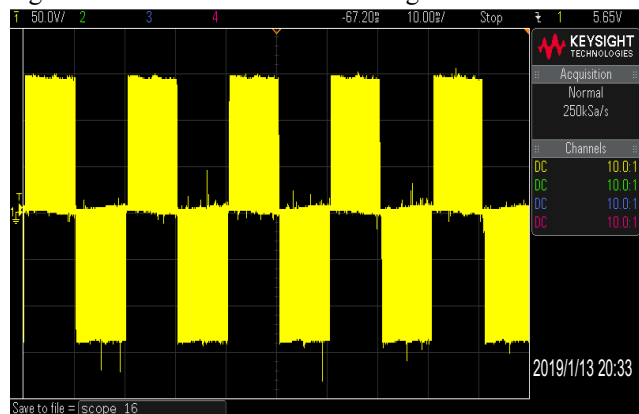

Figure 19 Hardware prototype output current waveform

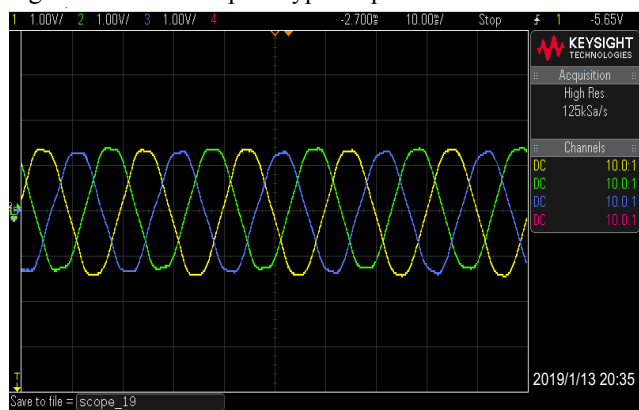

Figure 20 Hardware prototype output Voltage waveform

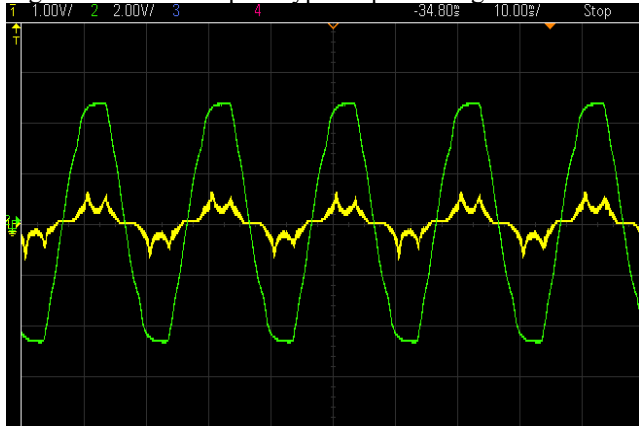

Figure 21 Hardware prototype input current & input voltage waveforms

## 7. Conclusion

This proposed mutated PSO based switching generation approach improves the control behaviour of MC systems. The proposed dual MC system for variable wind energy conversion system was successfully implemented in software and the MC fed IM Drive performance was implemented in the hardware. The suggested controller can line the three reference currents of the 3-phase system jointly and provides exhorted outputs successfully in the described load frequency. The complete evaluation of the algorithm shows that the control behaviour of SMPSO is more superior to the other. The consequences decrease the output voltage THD from 21.76% to 5.02%. The prospective method outcome was implemented using the hardware prototype with induction motor load and are validated. The proposed control strategy could be applied to the dual MC variable speed wind energy conversion system strongly. The future researchers can use the different advanced metaheuristic optimization techniques to further improvement of MC based wind energy conversion system

## References

- [1] A. Miller, E. Mujadi, D. zinger. "A Variable speed wind turbine power control" IEEE trans on energy conversion, Vol.12, No.2, pp-181-186, June 1997.
- [2] S. Mullar, M. Deicke, R.W. DE DeDuncker "Doubly fed induction generator system for wind turbines" IEEE industry applications magazine, pp26-33, May/june 2002.
- [3] I. Takahshi, T.noguchi "a new quick response and high efficiency control of and induction motor" IEEE transactions on industry on industry applications, Vol. IA-2, N.S. Sept/Oct 1986, pp.820-827.
- [4] Z. Liu, O. A. Mohammed and S. Liu " A Novel direct torque control of doubly fed induction generator used for variable speed wind power generation",IEEE Power Engineering Society General Meeting, 24-28 June 2007.
- [5] Masood Moghaddami , Arif I. Sarwat "Single phase soft switched AC-AC matrix converter with power controller for bidirectional Inductive power transfer systems",IEEE Transactions on Industry Applications, volume: 54, issue: 4, pp: 3760 – 3770, 2018.
- [6] Jianwei Zhang, Li Li, Tingting He, Mahlagha Madhavi Aghdam, David G. Dorrell "Investigation of direct matrix converter working as a versatile converter (AC/AC, AC/DC, DC/AC, DC/DC conversion) with predictive control", 43rd Annual Conference of the IEEE Industrial Electronics Society, Beiging, China, pp: 4644-4649, 2017.
- [7] Daphne Schwanz, Azam Bagheri, Math Bollen, Anders Larsson "Active harmonic filters: Control techniques review", 17th International Conference on harmonics and quality of power, Belo horizonte, Brazil, pp: 36-41, 2016.
- [8] Jianwei Zhang, Li Li, David G. Dorrell "Control and applications of direct matrix converters: A review",

- Chinese Journal of Electrical Engineering, volume: 04, issue: 2, pp: 18-27, 2018.
- [9] P. W. Wheeler, J. Rodriguez, J. C. Clare, L. Empringham, A. Weinstein "Matrix converters: a technology review", IEEE Transactions on Industrial Electronics, volume: 49, issue: 02, pp: 276-288, 2002.
- [10] P. Sweetey Jose, N. Chandra Deepika, S. N. Nisha "Applications of single phase matrix converter", International Conference on Emerging Trends in Electrical and Computer Technology, Nagercoil, India, pp: 386-391, 2011.
- [11] H. Nikkhajoei, R. Iravani "Application of Matrix Converter for Large Induction Machines", IEEE Power Electronics Specialists Conference, Orlando, USA, pp 2535-2540, 2007.
- [12] Jose Rodriguez, Marco Rivera, Johan W. Kolar, Patrick W. Wheeler "A Review of control and modulation for Matrix Converters", IEEE Transactions on Industrial Electronics, volume: 59, issue: 1, pp: 58-70, 2012.
- [13] Pelly, B. "thyristor phase controlled converters and cycloconverters", Wiley-interscience, New York, 1971.
- [14] Gyugi L, Pelly B Static power frequency changers: theory, performance and applications. Wiley-interscience, New York, 1976.
- [15] Venturini M, Alesina A, The generalized transformer: a new bi-directional sinusoidal waveform frequency converter with continuously adjustable input power factor, In: Proceedings of IEEE power electronics specialists conference, PESC'80, pp 242-252, 1980.
- [16] Roy G, April GE, Cycloconverter operation under a new scalar control algorithm, In: Proceedings of power electronics specialist's conference, vol 1, Milwaukee, US, pp 368-375, 1989.
- [17] Roy G, April GE, Direct frequency changer operation under a new scalar control algorithm, IEEE Trans Power Electron 6(1):100-107, 1991.
- [18] Roy G, Duguay L, Manias S, April GE, Asynchronous operation of cycloconverter with improved voltage gain by employing a scalar control algorithm, In: Proceedings of IEEE-IAS annual meeting, pp 889-898, 1987.
- [19] Huber L, Borojevi'c D, Space vector modulated three-phase to three-phase matrix converter with input power factor correction, IEEE Trans Ind Applications 31(6):1234-1246, 1995.
- [20] Tomas Laskody, Michal Prazenica, Slavomir Kascak "Space vector pulse width modulation for two-phase two-stage matrix converter with four legs", International Conference on Applied Electronics, Pilsen, Czech republic, pp: 181-184, 2014.
- [21] Keping You, Dan Xiao, Muhammed Fazlur Rahman, M. Nasir Uddin "Applying reduced general Direct Space Vector Modulation Approach of AC-AC matrix converter theory to achieve Direct Power Factor Controlled Three Phase AC - DC Matrix Rectifier", IEEE Transactions on Industry Applications, volume: 14, issue: 3, pp: 2243-2257, 2014.
- [22] J. Rodriguez, J. Espinoza, M. Rivera, F. Villarroel, C. Rojas "Predictive control of source and load currents in a direct matrix converter", IEEE International Conference on Industrial Technology, Chile, pp: 1826-1831, 2010.
- [23] Hanbing Dan, Qi Zhu, Tao Peng, Sun Yao, Patrick Wheeler "Preselection algorithm based on predictive control for direct matrix converter", IET Electric Power Applications, volume: 11, issue: 5, pp: 768-775, 2017.
- [24] Takuya Shindo, Kenya Jin'no "Particle swarm optimization for matrix converter of switching pattern design", IEEE Asia Pacific Conference on Circuits and Systems, Jeju, South Korea, pp: 309-312, 2016.
- [25] Rajib Baran Roy, Jerome Cros, Enamul Basher, Shaiyek Md. Bul and Taslim "Fuzzy logic based matrix converter controlled induction motor drive", IEEE Region 10 Humanitarian Technology Conference, Dhaka, Bangladesh, pp: 489-493, 2017.
- [26] Alireza Jahangiri, Ahmad Radan "Eliminating current sensors of indirect matrix converter using neuro fuzzy controller", European Conference on Power Electronics and Applications, Birmingham, UK, 1-10, 2011.
- [27] N. Niassati, M. Bagher, A.M. Sadati, A. Hajihosseini, E. Afjei "Improvement of output voltage and input current for a matrix converter using genetic algorithm", International Conference on Cyber Technology in Automation, Control, and Intelligent Systems, Bangkok, Thailand, pp: 238-242, 2012.
- [28] T.S Sivarani, S. Joseph Jawhar, C. Agees Kumar "Novel intelligent hybrid techniques for speed control of electric drives fed by matrix converter", International Conference on Computing, Electronics and Electrical Technologies, Kumaracoil, India, pp: 466-471, 2012.
- [29] Haluk Gözde, M. Cengiz Taplamacioglu "A simulation study of crazy-PSO controller for Direct Matrix Converter", International Conference on Electrical and Electronics Engineering, Bursa, Turkey, pp 107-111, 2013.
- [30] T. Satish, K. K. Mohapatra, Ned Mohan "Dynamic performance of a matrix converter fed speed sensorless DTC induction motor drive using adaptive speed observer" IEEE Applied power electronics conference and exposition (APEC), pp 1984 - 1990, 2009.
- [31] Kyo-Beum Lee, Frede Blaabjerg, "A novel unified DTC-SVM for sensorless induction motor drives fed by a matrix converter" 14th IAS annual industry applications conference, pp 2360-2366, 2005.
- [32] Vahid Faraji, Davood Arab Khaburi "A new approach to DTC-ISVM for induction motor drive system fed by indirect matrix converter" 2nd power electronics,

- drive systems and technologies conference, pp 367-372, 2011.
- [33] Yaohua Li, Weiguo Liu" A novel direct torque control method for induction motor drive system fed by two-stage matrix converter with strong robustness for input voltage", 2nd IEEE conference on industrial electronics and applications(ACIEA), pp 698-702,2007.
- [34] Ruzlaini Ghoni, Ahmed N. Abdalla, Zahim Sujod" Direct torque control for matrix converter-fed three phase induction motor with hybrid PSO" Journal of theoretical and applied Information Technology, pp 36- 40,2010.
- [35] Rene Vargas, Jose Rodriguez, Ulrich Ammann, Patrick W. Wheeler" Predictive current control of an induction machine fed by a matrix converter with reactive power control" IEEE Transactions on Industrial Electronics, Vol. 55, No. 12, pp 4362-4371,2008.
- [36] R. R. Joshi, R. A. Gupta, and A. K. Wadhawani "Intelligent controller for DTC controlled matrix converter cage drive system" Iranian journal of electrical and computer engineering, Vol. 7, No. 1,2008.
- [37] Brahim Metidji, Ahmed Azib, Farid Tazerart, Nabil Taib, Toufik Rekioua , "Fuzzy direct torque control with torque ripple reduction for induction motor drives fed by matrix converters" International Journal of Research and Reviews in Computing Engineering , Vol. 1, No. 1, , pp 23-28,2011.
- [38] Shamsheer Ansari, Aseem Chandel "Simulation based comprehensive analysis of direct and indirect matrix converter fed asynchronous motor drive", 4th IEEE Uttar Pradesh Section International Conference on Electrical, Computer and Electronics, Mathura, India, pp: 9-15, 2017.
- [39] Hongwu She, Hua Lin, Xingwei Wang, Limin Yue " Damped input filter design of matrix converter", International Conference on Power Electronics and Drive Systems, Taipei, Taiwan, pp: 672-677, 2009.
- [40] Huluk Gozde "Comparative analysis of swarm optimization-based control method for direct matrix converter", Electrical Engineering, volume: 97, issue: 3, pp: 181-193, 2015.
- [41] M Venturi "New wave sine wave, sine wave out technical conversion eliminates reactive elements", 7th National Solid State Power Conversion Conference, Calif, USA, pp: 1-15, 1980.
- [42] K.Harinadha Reddy, Ch.Amarendra," PSO Algorithm Support Switching Pulse Sequence ISVM for Six-Phase Matrix Converter-Fed Drives", Smart Intelligent Computing and Applications (International Conference on SCI), 559-569, Oct 2018.
- [43] K.Harinadha Reddy, S.Govinda Raju, "Fuzzy autonym MFs to improve complex grid network security by fuzzy implication PSO algorithm for dealing of islanding ADCS mode", Int. J. Systems, Control and Communications, Vol.9, no.3, 230-254, June 2018.
- [44] R. Eberhart, J. Kennedy "A new optimizer using particle swarm theory", Sixth International Symposium on Micro Machine and Human Science, Nagoya, Japan, pp: 39-43, 1995.
- [45] Mohd Farhan Ngatman, Johan Mohd Sharif, Md Asri Ngadi "A study on modified PSO algorithm in cloud computing", 6th ICT International Student Project Conference, Malaysia, pp: 1-4, 2017.
- [46] Zhengang Ning, Liyan Ma, Zhenping Li, Wenjian Xing "A hybrid particle swarm optimization for numerical optimization", International Conference on Business Intelligence and Financial Engineering, Beijing, China, pp: 92-96, 2009.
- [47] X.-Y. Sun, X.-Z. Chen, R.-D. Xu, D.-W. Gong "Hybrid many objective particle swarm optimization set evolution", Eleventh World Congress on Intelligent Control and Automation, Shenyang, China, pp: 1324-1329, 2014.
- [48] Jiyang Dai, Jin Ying "Adaptive mutation based particle swarm optimization algorithm", UKACC International Conference on Control, Cardiff, UK, pp: 404- 408, 2012.
- [49] Debasree Saha, Suman Banerjee, Nanda Dulal Jana "Multi objective particle swarm optimization based on adaptive mutation", Third International Conference on Computer, Communication, Control and Information Technology, Hooghly, India, pp: 1-5, 2015.
- [50] Hui Wang, Changhe Li, Yong Liu, Sanyou Zeng"A Hybrid Particle Swarm Algorithm with Cauchy Mutation", IEEE Swarm Intelligence Symposium, Honolulu, USA, pp: 356-360, 2007.
- [51] Millie Pant, Radha Thangaraj, Ved Pal Singh, Ajith Abraham "Particle swarm optimization using Sobol mutation", First International Conference on Emerging Trends in Engineering and Technology, Maharashtra, India, pp: 367-372, 2008.
- [52] Tuğçe Demirdelen, Emel Bakmaz, Mehmet Tumay, "A fuzzy neural network approach to estimate PMSG based and DFIG based wind turbines' power generation", Innovative Computing Technology (INTECH) 2017 Seventh International Conference on, pp. 101-106, 2017.
- [53] Jinxin Ouyang, Ting Tang, Yanbo Diao, Mengyang Li, Jun Yao, "Control method of doubly fed wind turbine for wind speed variation based on dynamic constraints of reactive power", Renewable Power Generation IET, vol. 12, no. 9, pp. 973-980, 2018.
- [54] Gustavo Figueiredo Gontijo, Thiago Cardoso Tricarico, Leonardo Francisco da Silva, Daniel Krejci, Bruno Wanderley França, Mauricio Aredes, Josep M. Guerrero, "Modeling Control and Experimental Verification of a DFIG With a Series-Grid-Side Converter With Voltage Sag Unbalance and Distortion Compensation Capabilities", Industry Applications IEEE Transactions on, vol. 56, no. 1, pp. 584-600, 2020.