

A Fuzzy Logic-Based MPPT Technique for PMSG Wind Generation System

Ahmed A. Salem*‡, Noura A. Nour Aldin **, Ahmed M. Azmy***, Walid S. E. Abdellatif **

*‡Electrical Engineering Department, Faculty of Engineering, Suez Canal University 41522 Ismailia, Egypt

** Electric Department, Faculty of Industrial Education, Suez University, Suez, Egypt

*** Electrical Power and Machines Engineering Depart., Faculty of Engineering Tanta University, Tanta, Egypt

(ahmed_salem@eng.suez.edu.eg, eng_noura11111@yahoo.com, azmy@f-eng.tanta.edu.eg, walid.Abdellatif@suezuniv.edu.eg)

‡ Corresponding Author; Ahmed A. Salem, Faculty of Engineering, Suez Canal University 41522 Ismailia, Egypt, Tel: +201002484169, Fax: +20 643 218 977 ahmed_salem@eng.suez.edu.eg.

Received: 31.10.2019 Accepted:05.12.2019

Abstract- Permanent magnet synchronous generator (PMSG)-based wind turbine is considered as one of the promising technologies for generating electric power from wind energy. This paper presents an artificial intelligent technique based on fuzzy logic controller (FLC) to enhance the maximum power point tracking (MPPT) of PMSG-based wind turbine. The FLC method is compared with the conventional methods of MPPT to clarify the superior features of the proposed technique. The comparison between the MPPT methods have been accomplished based on the speed response and new evaluation where the overall system efficiency is considered. A complete model of PMSG with a back to back (BTB) converter along with the control system considering different MPPT techniques is conducted using MATLAB/Simulink® platform. To reveal the robustness and the feasibility of control system, the system is examined under different wind speed profiles. On the basis of the results, good tracking with high accuracy and lower oscillation rate are obtained after using FLC. Moreover, the overall system efficiency is enhanced compared with other MPPT schemes.

Keywords Fuzzy logic controller (FLC); Maximum power point tracking (MPPT); Permanent magnet synchronous generator (PMSG); Wind turbine efficiency.

1. Introduction

With the increase of electrical energy demand, wind turbines became one of the important facilities for generating renewable and clean electric power. Mainly, there are many essential reasons for using more wind energy on power grids. For example, wind generation is supported by not only being clean and renewable but also having minimal running cost requirements [1]. Variable speed wind turbine (VSWT) topologies contain different generator/converter configurations, based on cost, efficiency, annual energy capturing, and control complexity of the overall system. PMSG-based VSWT is considered a promising and feasible technology in wind generation industry since PMSGs are

self-excited, and thus, allows operation at high power factor and high efficiency. Furthermore, due to its low rotational speed, the gearbox can be avoided. This feature in PMSG-based wind turbine is very important, where the gearbox is one of the most critical turbine components in other wind turbine, such as doubly fed induction generator (DFIG), since its failure is highly expected. Hence, it requires careful and regular maintenance [2]. PM machines have two types, i.e., PMDC and PMAC machines. The PMDC machines are similar to the DC commutating machines, with only one difference, where the field winding is replaced by the permanent magnets. In case of PMAC machines, the field is generated by the permanent magnets, which are located on

the rotor. Moreover, the brushes and the commutator do not exist in this machine type.

In modern wind turbines, MPPT control schemes should be implemented to get the full benefits from the wind speed. Assortment of MPPT techniques is used in wind turbines to adapt the generator speed with the optimal speed. Example are: hill climbing search, constant tip speed ratio (TSR), power signal feedback (PSF), optimum torque (OT), incremental conductance (INC), perturbation and observation (P&O) and artificial intelligent techniques [3]. Each technique has its advantages and disadvantages for driving the MPPT scheme. For example, TSR is highly efficient but needs accurate anemometer for measuring wind speed, which increases system cost [4]. On the other hand, PSF and OT do not require anemometer but the parameters of wind turbines are essentials to obtain the maximum power curve, which differs from one wind turbine to another. In INC and P&O, the algorithms do not require turbine specifications or sensors, which improves system reliability, but these two techniques have slower response and oscillate around the maximum power point [5]. Moreover, they do not track the rapid variation of wind speed, which affects the system efficiency. To eliminate the restriction of the aforementioned conventional techniques, soft computing techniques based on artificial intelligence are used because of their high performance and large flexibility. FLC is considered one of the strongest and most reliable soft computing techniques for MPPT applications. The main advantage of the FLC is attributed to its capability to change the controller parameters very quickly in response to system dynamics without any estimated parameters [6-8]. This feature is very useful, especially with the capricious and stochastic nature of wind. In [9], a proposed wind generation system consisting of PMSG with uncontrolled rectifier is connected with the main grid. The output of the FLC is considered as the duty cycle of the boost converter. The maximum power is presented by adjusting the duty cycle of the DC-DC boost converter. On the other hand, in [10], a proposed system with FLC is applied with PMSG having diode bridge rectifier and boost chopper circuit connected with a dc load. Some limitations face these configurations, where the full capability of rotational speed control is not achieved even with FLC. This degrades the facility of maximum wind power capturing. In BTB converter set, a full regulation and flexible control of rotational speed is recognized. Consequently, maximum benefits of the FLC can be obtained.

In this paper, a soft computing technique based on FLC is used to enhance the MPPT controller of grid connected PMSG-based wind turbine with BTB converter. The behavior of MPPT controller with FLC technique is compared with TSR and PSF as conventional methods of MPPT to clarify the superior features of the proposed technique. The comparison between the proposed and conventional methods has been analyzed based on the speed

response. Moreover, new evaluation depending on the overall system efficiency is used to prove the feasibility of FLC technique compared with conventional methods at the same wind turbine conditions. The remainder of this paper is organized as follows. Section 2 introduces the modelling of wind system. In Section 3, the control of machine-side converter is described, while the MPPT schemes are presented in section 4. Section 5, presents the control of grid side converter. Simulation results are described in section 6. The efficiency of the wind system with different MPPT schemes is conducted in section 7. Finally, conclusions are given in Section 8.

2. Modelling of Wind Energy System

As described in Fig. 1, the rotor blades of the wind turbine convert the kinetic energy of the wind to mechanical energy and the PMSG converts the mechanical power to electrical power. The stator of PMSG is connected to the utility grid through a BTB converter. The BTB converter consists of two parts: the first one is the machine side converter (MSC), which is responsible to accomplish the MPPT strategy. The second part is the grid side converter (GSC) that is connected to the grid through ac filter, and is responsible to control the dc-link voltage and the reactive power. Complete configuration of PMSG along with its control system and MPPT techniques are conducted in Fig.1.

2.1 Mechanical Model of wind turbine

The mechanical torque T_m produced by wind turbine can be represented by the block diagram shown in Fig. 2. Based on Fig.2, at a certain wind speed, the mechanical power produced by wind turbine depends on turbine blade R , air density ρ and the turbine power coefficient C_p , which depends on the turbine parameters. Moreover, C_p is taken as a function of two important factors: the TSR (λ) and the pitch angle (β). The relation between C_p , λ and β is formulated in Eq.(1) [11] and [12]:

$$C_p = C_1 \left(\frac{C_2}{\lambda_i} - C_3\beta - C_4 \right) e^{-\frac{C_5}{\lambda_i}} + C_6\lambda \quad (1)$$

The parameters λ_i and C_1 - C_6 are given in the appendix.

Figure 3 illustrates the relation between P_m - ω_m with various wind speeds. To ensure maximum power capture from wind speed, the turbine should operate at maximum power coefficient (C_{p_max}), which meets the optimum TSR (λ_{opt}). Depending on the parameters of wind turbine, the maximum power occurs at the point, $\beta = 0^\circ$, and $\lambda_{opt} = 8.1$ and $C_{p_max} = 0.48$ as shown in Fig. 3.

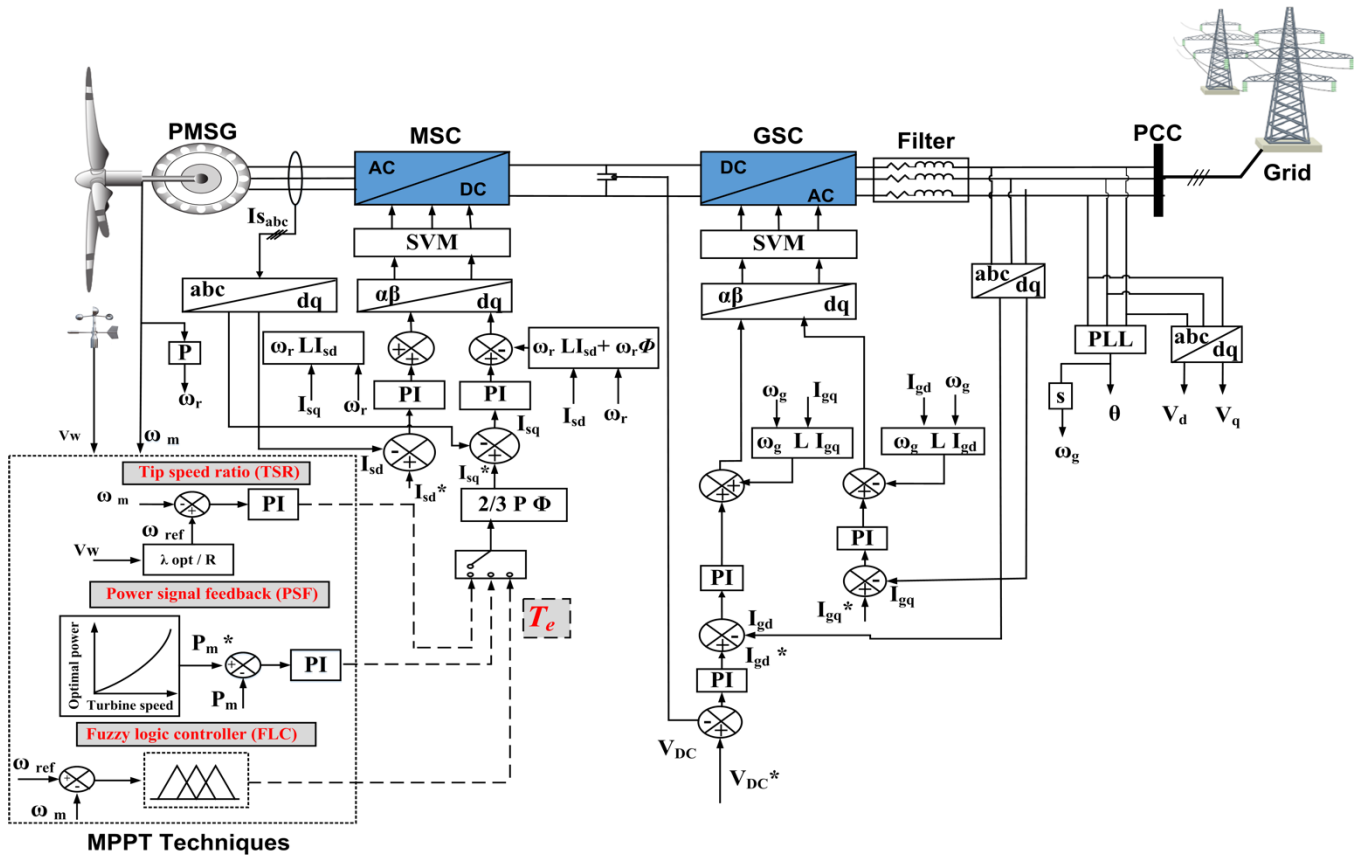

Fig. 1. The configuration of PMSG based wind turbine with the control system.

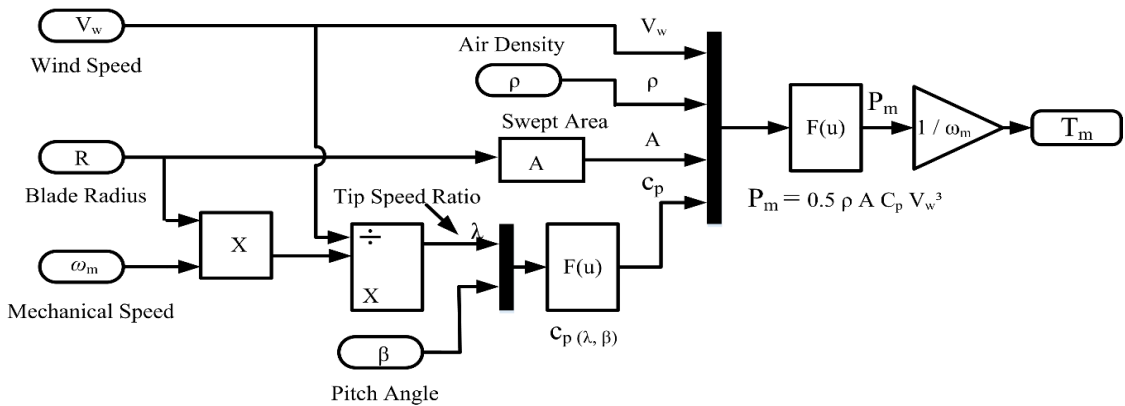

Fig. 2. Configuration of mechanical model.

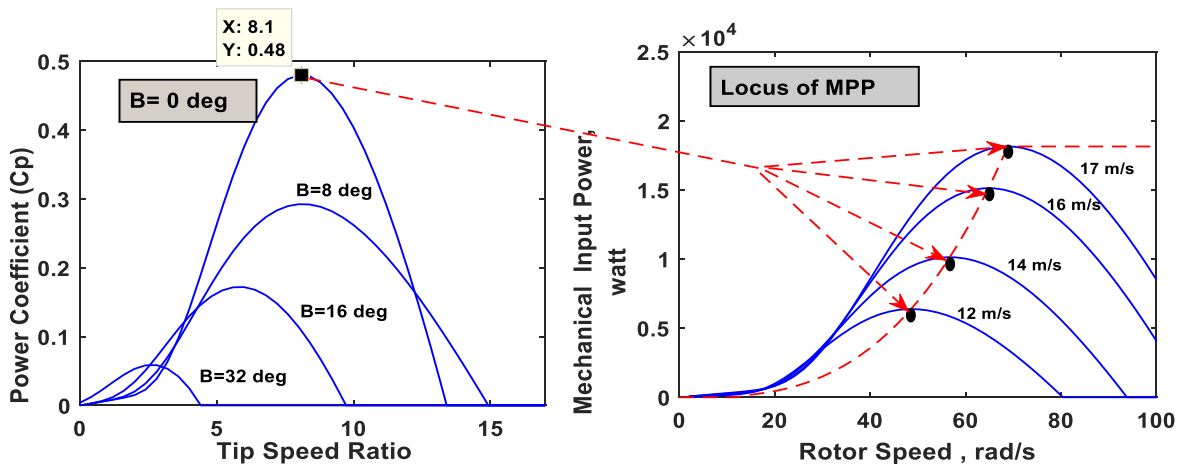

Fig. 3. Characteristic of wind turbine.

2.2 Modeling of PMSG

The dynamic model of the PMSG has been presented in [13-16]. The stator voltages V_{sd} and V_{sq} relating to dq reference frame can be described in Eq. (2) and (3):

$$V_{sd} = -R_s I_{sd} - L_s \frac{dI_{sd}}{dt} + L_s I_{sq} \omega_r \quad (2)$$

$$V_{sq} = -R_s I_{sq} - L_s \frac{dI_{sq}}{dt} + L_s I_{sd} \omega_r + \omega_r \phi \quad (3)$$

where, R_s and L_s are the stator resistance and inductance, respectively, the electrical angular speed is abbreviated as ω_r and ϕ is the permanent magnetic flux. The electromagnetic torque, T_e , is described in Eq. (4) [16], [17]:

$$T_e = \frac{3}{2} P I_{sq} ((L_d - L_q) I_{sd}) \quad (4)$$

where, L_d and L_q are the dq axis inductance with $L_d=L_q=L_s$ in surface mounted PMSG and P is the number of pole pairs. Consequently, the electromagnetic torque equation, i.e., (4) can be rewritten as shown in Eq.(5):

$$T_e = \frac{3}{2} P I_{sq} \phi \quad (5)$$

3. Control of Machine Side Converter

The MSC is used to control the turbine shaft speed to obtain the maximum power from the incident wind speed. This power occurs at $C_{p,max}$ which depends on β and λ . From Fig. 3, to attain $C_{p,max}$ the β must be zero. Moreover, λ should be maintained at its optimum value (i.e. $\lambda_{opt} = 8.1$). By this way, if the wind speed changes, the turbine shaft speed should be modified to fit the change in this wind speed. To clarify the control concept, the equation of motion for a typical generator is discussed in Eq. (6) [18].

$$J \frac{d\omega_m}{dt} = T_m - T_e - B N_t \quad (6)$$

where: J is the inertia of the whole system including the turbine and generator (kg.m²), while B is the friction factor (N.m.s).

Depending on Eq. (6), the electromagnetic torque (T_e) governs the generator rotational speed and, consequently, the speed control is achieved by generator torque control. From Eq. (5), the electromagnetic torque could be controlled directly by " I_{sq} " and, hence, the speed can be controlled by changing the q -axis current component. The d -axis current component " I_{sd} " is set to zero to minimize the current flow for a given torque and, thus, minimize the resistive losses [19]. Consequently, the MSC has two main loops, i.e., inner loop and outer loop. The inner loop is responsible of current control, while the outer loop is responsible of applying the MPPT technique.

4. MPPT Techniques

4.1 Conventional MPPT Techniques

There are many considerable techniques used to perform the MPPT. Briefly, this paper focuses on TSR and PSF as conventional techniques of MPPT. In TSR technique, the strategy depends mainly on keeping " λ " at its optimum value (i.e. $\lambda_{opt} = 8.1$) for all wind speeds. Consequently, this technique needs anemometer for measuring wind speed. As shown in Fig. 1, the measured generator speed " ω_m " is compared with the reference generator speed " ω_{ref} " and the error drives the control action to adjust the generator speed. The value of " ω_{ref} " can be written as shown in Eq. (7).

$$\omega_{ref} = \frac{\lambda_{opt} \cdot V_w}{R} \quad (7)$$

Although, PSF does not require anemometer, the parameters of wind turbines are still essential. The PSF technique depends on the knowledge of wind turbine maximum power curve (locus of MPP in Fig. 3), which can be performed through simulation or experimental test. As shown in Fig.1, measuring generator speed " ω_m " is needed to obtain reference power " P_{ref} ". The measured and reference power are compared and the error drives the control action to modify the generator speed.

4.2 Fuzzy logic controller

In PSF and TSR, the outer loop depends on the conventional proportional integral (PI) controller, which offers simple control structure and high robustness, especially at steady state. However, this controller undergoes high sensitivity to the system nonlinearity and uncertainty. Many optimization techniques are used to design the PI parameters, although these techniques increase the system complexity and need more computational analysis. To defeat the drawbacks of PSF and TSR, FLC controller is used. FLC, is first proposed by Lotfi Zadeh [20], where the aim of FL was to develop an output by allowing a set of membership functions to decide the value of the inputs rather than representation using crisp deterministic values. The main feature is the use of linguistic variables rather than numerical variables. Fuzzy based controllers have been found to be excellent choices for many control applications, as they imitate human control logic closely. The fuzzy rules are framed on the basis of the expert knowledge gained by the study of the performance of the system over a period of time. This concept is very useful for handling the nonlinearity and uncertainty of the system and, moreover, gives superior feature regarding fast convergence especially at transient state [21]. Thereby, FLC-based MPPT technique is considered a promising and strong algorithm, especially with fast changes in wind speed.

As conducted in Fig. 4, the input quantities of FLC are the error of the generator speed (e) and the variation of this error (Δe). The symbol " Z^{-1} " is the unit time delay. The output of FLC is the change in electromagnetic torque (ΔT_e). The input and output are normalized through scaling factors K_e , $K_{\Delta e}$ and $K_{\Delta T_e}$. The inputs of FLC are expressed in Eq. (8) and (9) [22]:

$$e = \omega_{ref} - \omega_m \tag{8}$$

$$\Delta e = (1 - Z^{-1})e \tag{9}$$

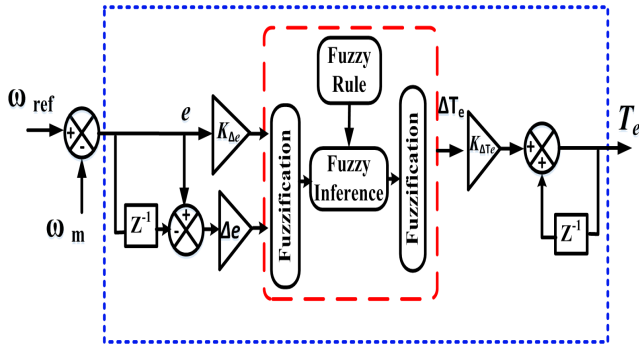

Fig. 4. FLC based MPPT technique.

The function of FLC controller in this paper is to perturb the reference torque and to observe the change of the speed “e”. If the speed increases with the last torque increment, the searching procedures continue in the same direction. Otherwise, the search process is reversed. Consequently, the generator speed matches its reference. As shown in Fig. 4, FLC consists, generally, of three parts; 1- fuzzification, 2- fuzzy Rule base, 3- defuzzification, which will be explained in the following:

A. Fuzzification

Each input/output variable used in the controller design is expressed in fuzzy set notation using linguistic variables. For example, the notations of speed error “e”, the variation of speed error “Δe” and change in electromagnetic torque “ΔT_e” Negative Big (NB), Negative Small (NS), Zero (ZE), Positive Big (PB), Positive Small (PS) are characterized by the triangular membership function as conducted in Fig.5. The triangular membership is selected for its faster process compared with Gaussian membership function. The input and output are normalized through scaling factors for convenience to improve the dynamic and transit performance of the controller.

B. Fuzzy logic rules

After defining the fuzzy sets, a control strategy is defined by a set of IF-THEN rules [23]. Based on authors expert control knowledge of the PMSG wind turbine system operation, these heuristic rules are expressed in fuzzy domain as shown in Table 1. For example, if (Error “e” is NB) and (Derivative “Δe” is NB), then (change in electromagnetic torque “ΔT_e” is NB).

C. Defuzzification

As following step, we need to transform the output linguistic variables to crisp values for controlling the electromagnetic torque. The method used to complete the controller objective is the center of gravity technique, which is given by Eqs. (10) and (11) [24]:

$$\Delta T_e = K_{\Delta T_e} \frac{\sum_{i=1}^{25} \mu_i C_i}{\sum_{i=1}^{25} \mu_i} \tag{10}$$

$$T_e(k) = T_e(k-1) + \Delta T_e \tag{11}$$

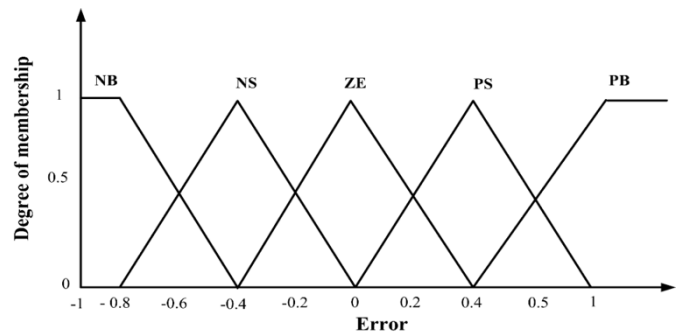

Fig. 5. The inputs and output of the membership function.

Table 1. Rule base of FLC.

Output		e(t)				
		NB	NS	ZE	PS	PB
Δe(t)	NB	NB	NB	NS	NS	ZE
	NS	NB	NS	ZE	ZE	PS
	ZE	NB	NS	ZE	ZE	PS
	PS	NS	PS	PS	PS	PB
	PB	ZE	PS	PB	PB	PB

5. Control of the Grid Side Converter

As shown in Fig.1, the function of the GSC is to connect the PMSG wind generation system with utility grid. Moreover, the GSC is used to regulate the dc link voltage at its nominal value under various conditions. Consequently, it ensures that the active generated power is fed to the grid, where the capacitor voltage always varies during wind turbine operation. Furthermore, one of the main objectives of GSC is controlling the reactive powers delivered to the grid. Hence, unity power factor flow (zero reactive power exchange) could be easily obtained. Full description of GSC control has been extensively presented in many articles [11-19].

6. Simulation Results

To validate the response of the control system based on the aforementioned MPPT techniques, two case studies of wind speed profile are conducted. First case assumes that the wind speed profile varies as step functions (up and down) with an average wind speed of 11.28 m/s. The second case assumes that the wind speed profile changes randomly with an average wind speed of 12 m/s and turbulence intensity of

40%. The proposed FLC technique is compared with the conventional MPPT techniques (TSR and PSF). The parameters of the whole system are listed in the appendix. A complete model of PMSG with a BTB converter along with the control system considering different MPPT techniques is conducted using MATLAB/Simulink® platform.

6.1 Case (1): step changes in wind speed

As described in Fig. 6(a), the wind speed profile varies with steps over 5 s time span. As shown in Fig. 6(b) the MSC can govern the power coefficient “ C_p ” to be maintained at its maximum value, i.e., 0.48, with the three MPPT techniques. However the system response is enhanced when FLC is used compared to PSF and TSR. Similar results are obtained in Fig. 6(c) and 6(d). In Fig. 6(c), the λ is conducted and, hence, the λ is forced to sustain at its optimal value, i.e., 8.1. Fig. 6(d) presents the rotor speed of the generator, which tracks the reference speed, denoting the capability of MSC to afford the MPPT strategy. Figure 6(e) depicts the mechanical power of wind turbine under the three techniques of MPPT. Based on the results, It is worth mentioned that, the enhancemnt of FLC is attributed to its capability to change the controller parameters very quickly in response to system dynamics particularly when the wind speed changes suddenly.

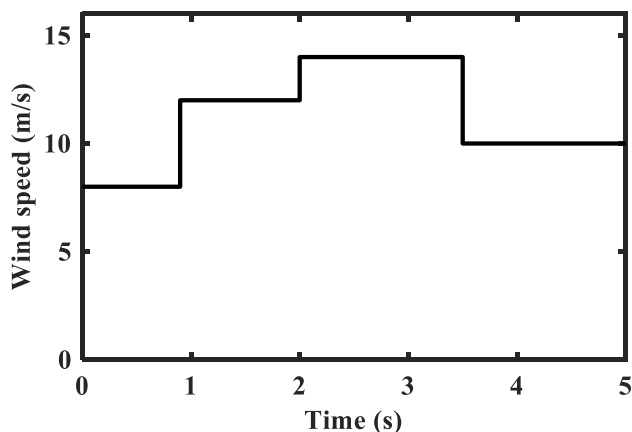

a). Wind speed profile.

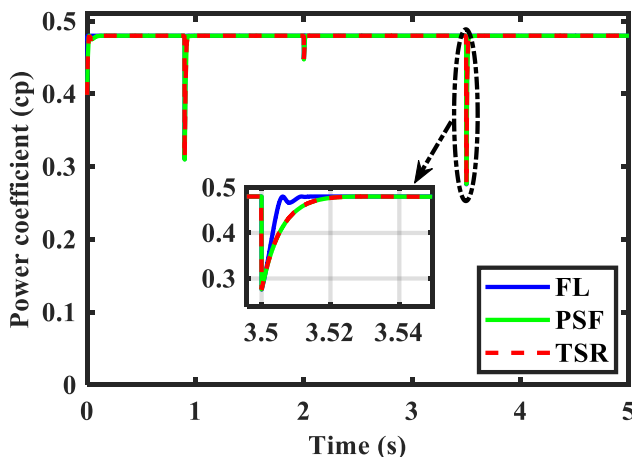

b). Power coefficient (C_p) of the turbine.

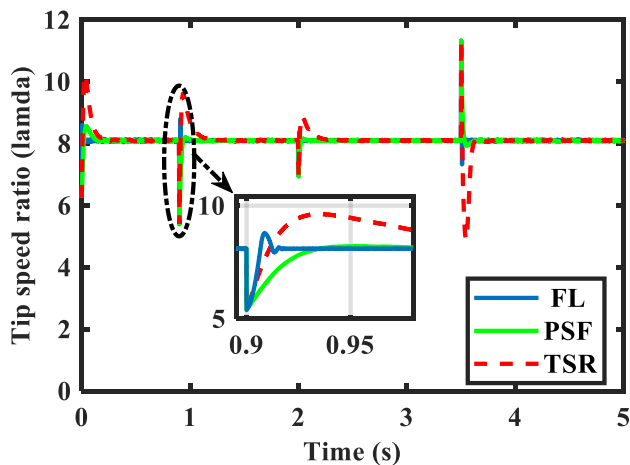

c). Tip speed ratio (λ).

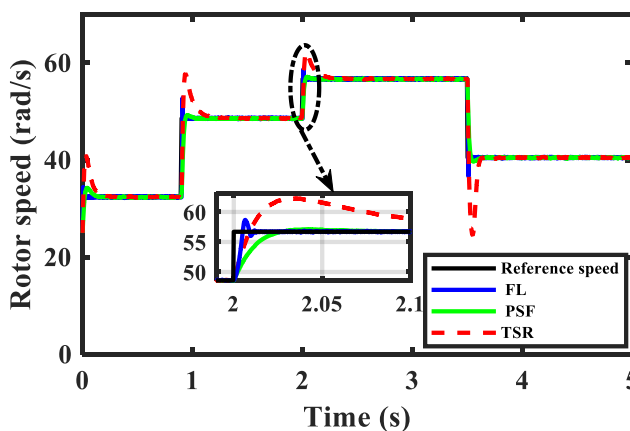

d). Rotor speed (rad/s).

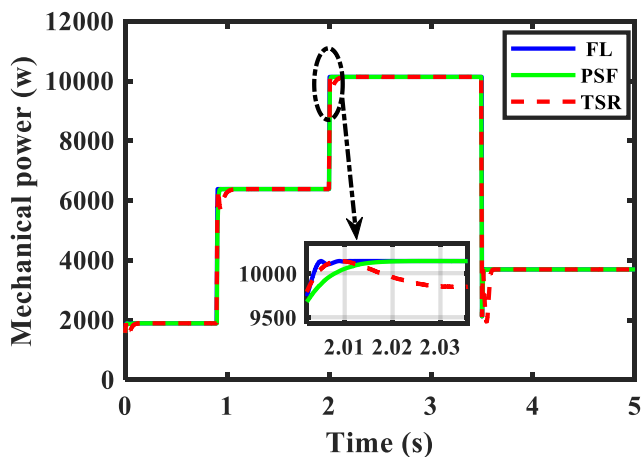

e) Mechanical power.

Fig. 6. Response of wind turbine under Step change in wind speed profile.

6.2 Case (2): random changes in wind speed

In this section, the feasibility of the control system to attain MPPT is examined depending on random changes in wind speed, with an average wind speed of 12 m/s and turbulence intensity of 40 %. A wind speed time series is given according to the equivalent wind speed model provided in Wind Turbine Blockset, Matlab/Simulink [25]. The

portrayed wind speed profile is depicted in Fig. 7(a). Figures 7(b) and 7(c) prove that the MPPT is achieved, with the power coefficient “ C_p ” and λ are maintained at their maximum and optimal vlues, repectively. The afford of the MSC to track the rotor speed with its reference value is presented in Fig. 7(d). Figure 7(e) describes the mechanical power captured by the wind. based on the simulation results, its clear that the system response with FLC gives better tracking capability and the oscilation rate is reduced compared to PSF and TSR.

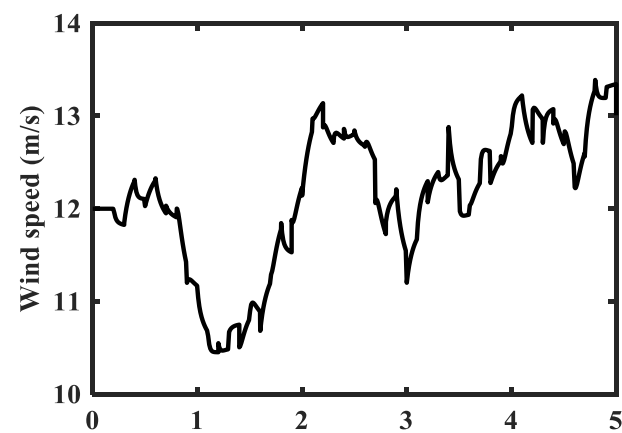

a). Wind speed profile.

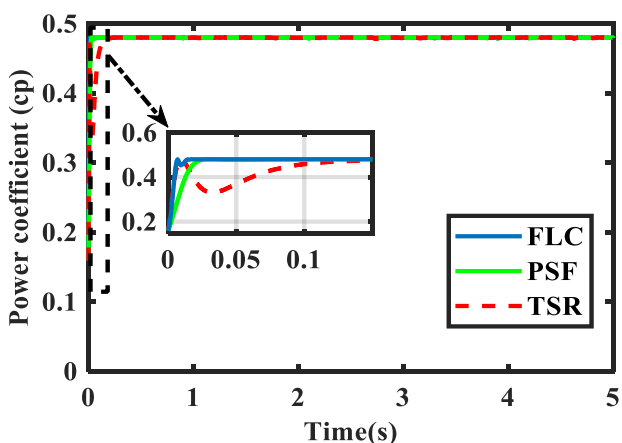

b). Power coefficient (Cp).

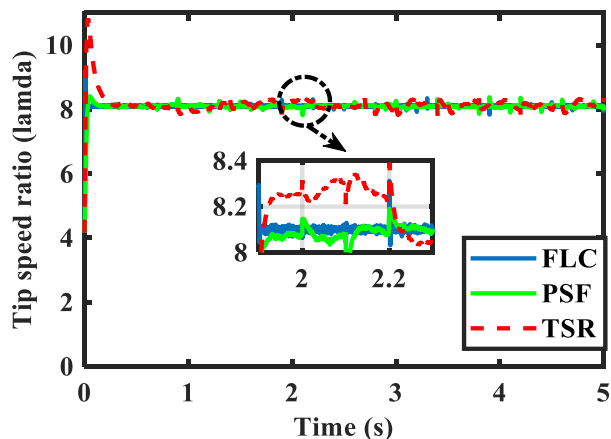

c). Tip speed ratio (λ).

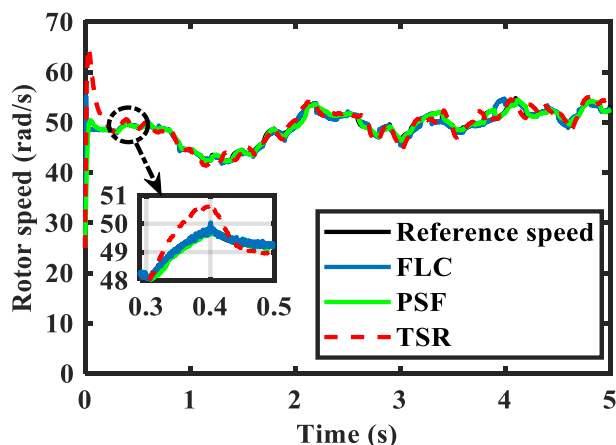

d). Rotor speed (rad/s).

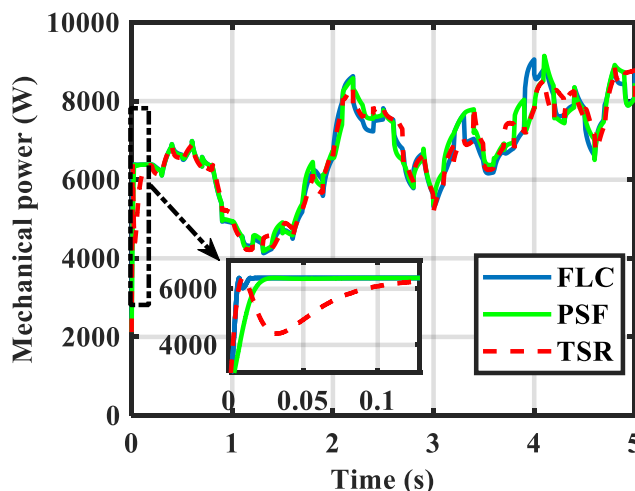

e). Mechanical power.

Fig. 7. Response of wind turbine under Random change in wind speed profile.

7. The efficiency of wind system with different MPPT schemes

In this section, a new evaluation is used depending on the overall system efficiency to prove the feasibility of FLC technique compared with conventional methods under the same wind turbine conditions. To study the efficiency of PMSG-based wind generation system, the following formula is used as shown in Eq. (12) [26]:

$$\eta_{sys} = \frac{\int_0^t P_g}{\int_0^t P_{th}} \times 100 \% \quad (12)$$

where η_{sys} is the efficiency, P_g is the grid active power and P_{th} is the theoretical mechanical power taken in optimal conditions.

Briefly, the system efficiency is examined under wind speed profile considered in case (1), i.e., Fig. 6(a). As shown in Fig. 8, the grid active powers for FLC, PSF and TSR are compared with the theoretical power. To ensure the validity of the GSC controller, the grid voltage and the injected grid current are presented in Fig. 9, where unity power factor

operation is achieved and, hence, the voltage and current are in phase.

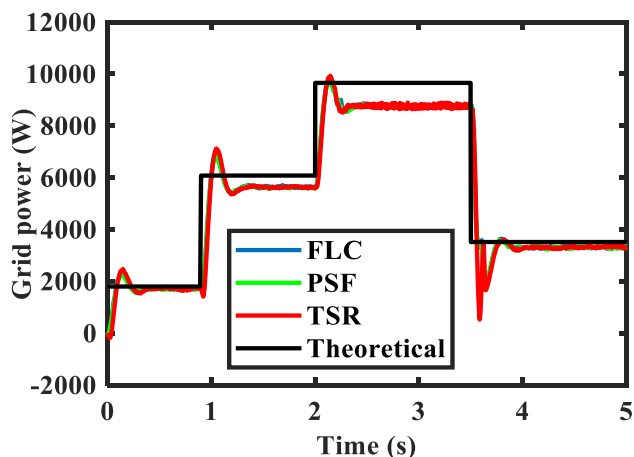

Fig. 8. Grid active power.

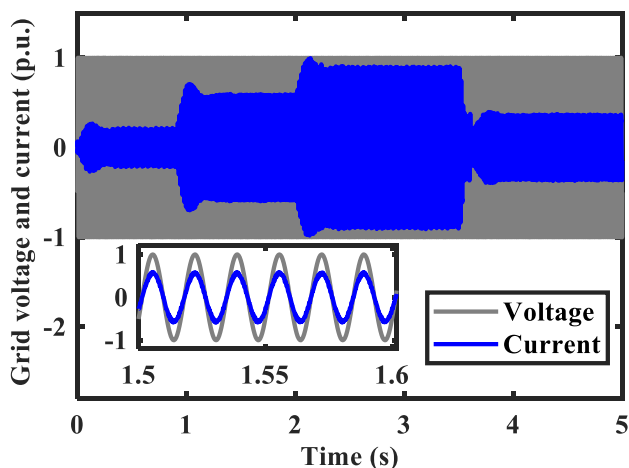

Fig. 9. Grid voltage and current for FLC scheme.

Fig. 10 describes the overall efficiency of the system with FLC, TSR and PSF. As shown in Fig. 10(a), the efficiency of the wind turbine system is enhanced with FLC compared with PSF and TSR. The FLC technique improves the system efficiency to 92% compared with 85.44% for TSR and 87.12% for PSF as declared in Fig. 10(b).

(a)

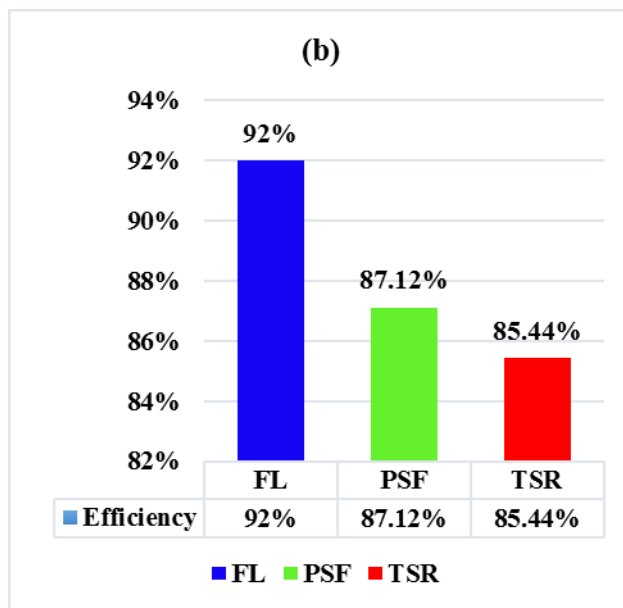
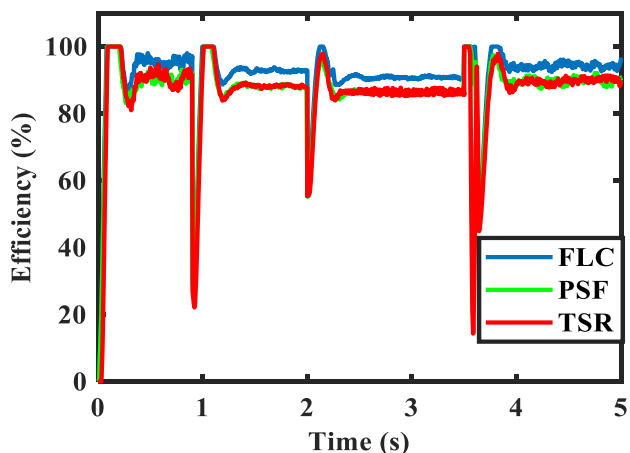

Fig. 10. The efficiency of of PMSG wind generation system.

8. Conclusion

This paper presents an efficient MPPT technique to drive the MSC of the grid connected PMSG-based wind turbine with a BTB converter set under different wind speed profiles. The effectiveness of the MSC is examined depending on three techniques of MPPT schemes. First and second techniques are based on TSR and PSF as conventional methods, while the third technique is based on FLC as a soft computing technique. Based on extensive simulation results, the behavior of MSC with FLC gives better performance regarding the feasibility of MPPT. Hence, FLC gives good tracking capability and lower oscillation rate compared with TSR and PSF. The attitude of FLC is attributed to its capability to change the controller parameters very quickly in response to system dynamics. The comparison between the three techniques has been investigated based on the speed response and the ability of the MPPT scheme to capture maximum power, which leads to increasing the overall system efficiency. The overall system efficiency is enhanced to 92% with FLC compared with 85.44% and 87.12% with TSR and PSF, respectively.

Appendix: Parameters of system components

Parameter	Value and unit
PMSG:	
• Stator resistance (R_s)	0.00829 Ω
• Stator direct inductance (L_d)	0.174 mH
• Stator quadrature inductance (L_q)	0.174 mH
• Permanent magnet flux (Φ)	0.071 wb
• Number of pole pairs (P)	6 pair pole
• Inertia of the whole system (J)	0.089 kg.m ²
• Friction factor (B)	0.005 N.m

Specification of wind turbine:	
• The coefficients c_1 to c_6 :	
c_1	0.5176
c_2	116
c_3	0.4
c_4	5
c_5	21
c_6	0.0068
• Wind turbine blade length (R)	2 m
• Air density (ρ)	1.225 kg.m ³
• Optimal tip speed ratio (λ_{opt})	8.1
• Maximum power coefficient ($C_{p,max}$)	0.48

References

[1] G. Gualtieri, "A comprehensive review on wind resource extrapolation models applied in wind energy," *Renewable and Sustainable Energy Reviews*, vol. 102, pp. 215-233, March 2019.

[2] F. Zohra Naama, A Zegaoui, "Model and Simulation of a Wind Turbine and its Associated Permanent Magnet Synchronous Generator," *International Journal of Engineering Science and Research (IJAER)*, vol. 4, Iss. 3, September 2018.

[3] A. Kader, H. Marzougui, "MPPT Control Methods in Wind Energy Conversion System using DFIG," 4th *International Conference on Control Engineering & Information Technology*, Tunisia, December 2016.

[4] S. Elkhadiri, P. Abdelouahid, "Fuzzy logic control of DFIG-based wind turbine," *International Conference on Intelligence System and Computer Vision (ISCV)*, Morocco, April 2018.

[5] D. Kumar, K. Chatterjee, "A review of conventional and advanced MPPT algorithms for wind energy systems," *Renewable and Sustainable Energy Reviews*, vol. 55, pp. 957-970, 2016.

[6] T. Poompavai, M. Kowsalya, "Control and energy management strategies applied for solar photovoltaic and wind energy fed water pumping system: A review," *Renewable and Sustainable Energy Reviews*, 2019.

[7] A. Harrouz, K. Nourdine, K. Kayisli, H. Bulbul and I. Colak, "A Fuzzy Controller for Stabilization of Asynchronous Machine," *International Conference on Renewable Energy Research and Applications (ICRERA)*, Paris, France, Oct. 2018.

[8] M. K. Al-Nussairi, R. Bayindir, E. Hossain, "Fuzzy logic controller for DC-DC buck converter with constant power load," *International Conference on Renewable Energy Research and Applications (ICRERA)*, San Diego, USA, Nov. 2017.

[9] B. Biharee, E. Sudhanshu, "Tracking of maximum power from wind using fuzzy logic controller based on PMSG," *International Journal of Modern Engineering Research (IJMER)*, Vol. 4, Iss.11, 2014.

[10] O. Zebraoui, M. Bouzi, "Comparative study of different MPPT methods for wind energy conversion system," *International Conference on Renewable Energies and Energy Efficiency (REEE)*, 2018.

[11] A. A. Daoud, S. S. Dessouky, and A. A. Salem, "Control scheme of PMSG based wind turbine for utility network connection," *International Conference on Environment and Electrical Engineering*, 2011.

[12] A. Belkaid, I. Colak, K. Kayisli, R. Bayindir "Modeling of a Permanent Magnet Synchronous Generator in a Power Wind Generation System with an Electrochemical Energy Storage," *International Journal of Smart Grid*, Vol.2, No.4, Dec. 2018.

[13] M. Chinchilia, S. Arnaltes, and J. Burgos, "Control of permanent-magnet generator applied to variable-speed wind-energy systems connected to the grid," *IEEE Transaction Energy Conversion*, vol. 21, no.1, Mar. 2006.

[14] M. Allouche, S. Abderrahim, H. Ben Zina, M. Chaabane, "A Novel Fuzzy Control Strategy for Maximum Power Point Tracking of Wind Energy Conversion System," *International Journal of Smart Grid*, vol.3, no.3, Sep. 2019.

[15] A. H. K. Alaboudy, A. A. Daoud, S. S. Desouky, and A. A. Salem "Converter controls and flicker study of PMSG-based grid connected wind turbines", *Ain Shams Engineering Journal*, vol. 4, no.1, pp. 75-91, 2013.

[16] B. Gianluca, M. Santolo et al., "Second order variable structure control for wind turbine pmsg-based and generator-side converter system," *International Conference on Renewable Energy Research and Applications (ICRERA)*, San Diego, USA, Nov. 2017.

[17] N. Ayadi, N. Derbel. "Nonlinear adaptive backstepping control for variable-speed wind energy conversion system-based permanent magnet synchronous generator" *The International Journal of Advanced Manufacturing Technology*, vol. 92, pp. 39-46, 2017.

[18] M. Chinchilia, S. Arnaltes, and J. Burgos, "Control of Permanent-Magnet Generator Applied to Variable-Speed Wind -Energy Systems Connected to the Grid," *IEEE Transaction Energy Conversion*, vol. 21, no.1, Mar. 2006.

[19] R. Krishnan, *Permanent magnet synchronous and brushless dc motor drives*, Taylor & Francis Group, CRC Press, 2010.

[20] L.A. Zadeh, Fuzzy sets, *Inform and Control*; vol. 8, no. 3, June 1965, PP. 338-353.

[21] T. Gaddam, and K. Danduprolu, "Fuzzy Logic Controller Based Performance of SPMSM Fed with Improved Direct Torque Control," *International Journal of Renewable Energy Research*, Vol 9, No 3, Sep. 2019.

[22] M. R. Cristian Lazaroiu, Dario Zaninelli, "Fuzzy logic to improve prosumer experience into a smart city," 2018 *International Conference on Smart Grid (icSMARTGrid)*, Japan, 4-6 Dec. 2018.

[23] L. Suganthi, S. Iniyan, A. A. Samuel, "Applications of fuzzy logic in renewable energy systems - a review",

Renewable and Sustainable Energy Reviews, vol.48, 585 - 607, 2015.

[24] M. A. Soliman, H. Hasaniien, H. Z. Azazi, E. E. El-kholy, and S. A. Mahmoud, "An adaptive fuzzy logic control strategy for performance enhancement of a grid-connected PMSG-based wind turbine," *IEEE Transactions on Industrial Informatics*, pp. 1-1, 2018.

[25] F. Iov, A.D. Hansen, P. Sorensen, F. Blaabjerg, Wind turbine blackest in Matlab/Simulink, Research Project, Institute of Energy Technology, Alborg University, March 2004.

[26] Ahmed I. M. Ali, Mahmoud A. Sayed and Essam E. M. Mohamed, "Modified efficient perturb and observe maximum power point tracking technique for grid-tied PV system", *Electrical Power and Energy Systems*, vol. 99, pp.192–202, 2018.